

**Model PM4-RS and PM4-RSA
Serial Input
Panel Mount Display/Controller
Arithmetic and Wind Speed/Direction
Addendum**

AMALGAMATED INSTRUMENT CO PTY LTD

ACN: 001 589 439

*Unit 5, 28 Leighton Place Hornsby
NSW 2077 Australia*

*Telephone: +61 2 9476 2244
Facsimile: +61 2 9476 2902*

*e-mail: sales@aicpl.com.au
Internet: www.aicpl.com.au*

Table of Contents

1	Introduction	3
2	Electrical installation	4
3	Function tables - Arithmetic mode	9
4	Arithmetic and Wind Speed/Direction mode functions	16
5	Arithmetic function examples	52
6	Function table - Wind Speed and Direction mode	53
7	Wind speed and direction NMEA mode	57



1 Introduction

This addendum to the PM4-RS manual contains information for the installation and operation using the arithmetic mode **Arth** or the wind monitor mode **NMEA**. Refer to the main PM4-RS and PM4-RSA manual for any details not covered in this addendum.

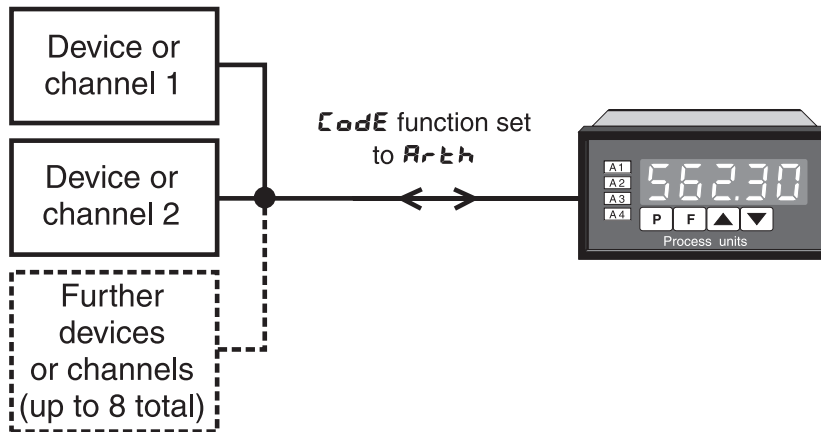

The PM4 will accept inputs from RS232, RS485, RS422 or serial current loop inputs (factory configured). The two modes covered by this addendum are detailed below. If the mode is changed it is necessary to remove power from the PM4 then reapply power in order to reset the mode.

Arithmetic mode. The instrument can be programmed to accept input from up to eight RS485 or RS422 sources and combine these arithmetically. The time between polling requests is programmable from 0.0 to 20.0 seconds. The instruments polled for arithmetic operation must be of the same manufacture as the PM4 instrument. To operate in this mode the **Code** function must be set to **Arth**.





PM4 polls external devices and displays arithmetic result or  &  can be used to display value of each device or channel. Polled devices must be of the same manufacture as the PM4. Communications must be RS485 or RS422 if more than one device is polled.

Wind speed and direction (NMEA). This mode is used only with instruments using NMEA (National Marine Electronics Association) serial code such as model WS-MMW-005 wind speed and direction sensor. To operate in this mode the **Code** function must be set to **NMEA**.

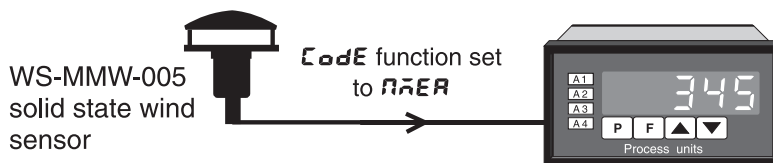
The display can be set to display wind speed, wind direction or to toggle (using  or  button) or automatically alternate the display between wind speed and direction. Analog retransmission output options can be selected to transmit wind direction (**Ch 1**) or wind speed (**Ch 2**) at the **FEC** function (also at the **FEC2** function if dual analog output is used.) Similarly **Ch 1** or **Ch 2** can be selected for the alarm relays at the **A 1, A2** etc. functions.



PM4 receives wind speed & direction information. Use  or  to toggle between speed & direction display. Operates with WS-MMW-005 sensor only.

2 Electrical installation

2.1 Electrical installation

The PM4 Panel Meter is designed for continuous operation and no power switch is fitted to the unit. It is recommended that an external switch and fuse be provided to allow the unit to be removed for servicing.

The plug in, screw type, terminal blocks allow for wires of up to 2.5mm² to be fitted. Connect the wires to the appropriate terminals as indicated below. Refer to connection details provided in this chapter to confirm proper selection of voltage, polarity and input type before applying power to the instrument.

When power is applied the instrument will cycle through a display sequence indicating the software version and other status information, this indicates that the instrument is functioning. Acknowledgement of correct operation may be obtained by applying an appropriate input to the instrument and observing the reading.

For connection details of optional outputs refer to the separate “PM4 Panel Meter Optional Output Addendum” booklet supplied when options are fitted.

Use twin shielded wire for RS232 connection and twisted pair shielded wire for RS485 and RS422.

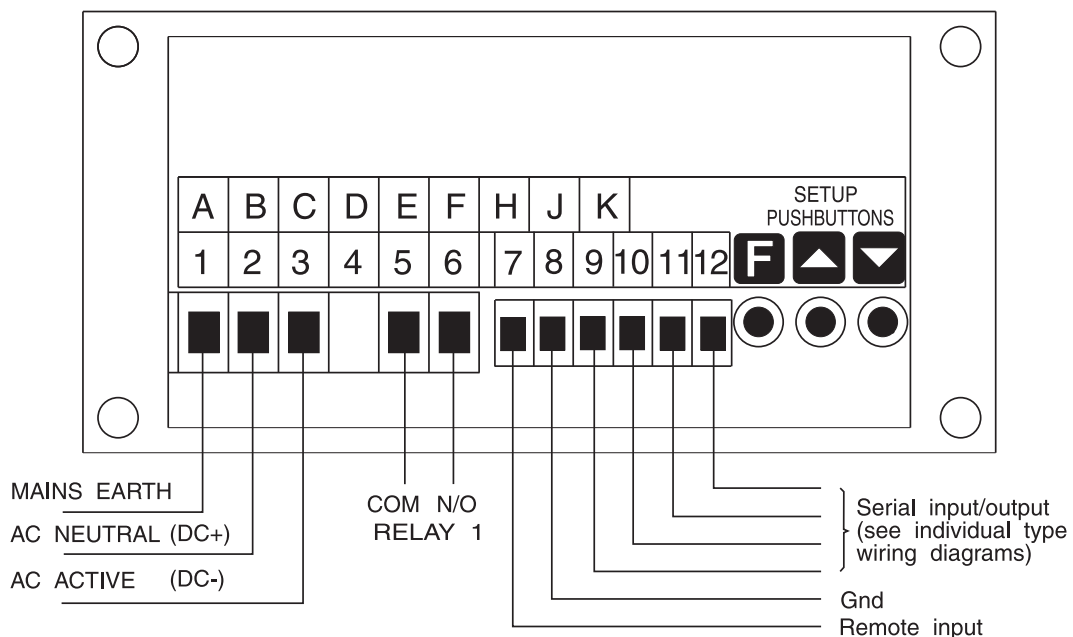

Instrument rear view

 N1440	
1	MAINS EARTH
2	240 VAC NEUTRAL
3	240 VAC ACTIVE
5	RELAY 1 COM
6	RELAY 1 N/O
7	REMOTE INPUT
8	GROUND
9	RS232 TX
10	RS232 RX
11	
12	
PM4-232-240-5E	
SERIAL No. : XXXXX-XXX	

Instrument data label example

2.2 RS232 connections

Use 3 core shielded cable for RS232 connections. RS232 connections generally have Rx at the PM4-RS connected to Tx at the PLC/Computer etc. and Tx at the PM4-RS connected to Rx at the PLC/Computer etc. RS232 connections are usually rated to a maximum cable length of approximately 15 metres and are single ended in operation i.e. only one device can be connected to the PM4-RS.

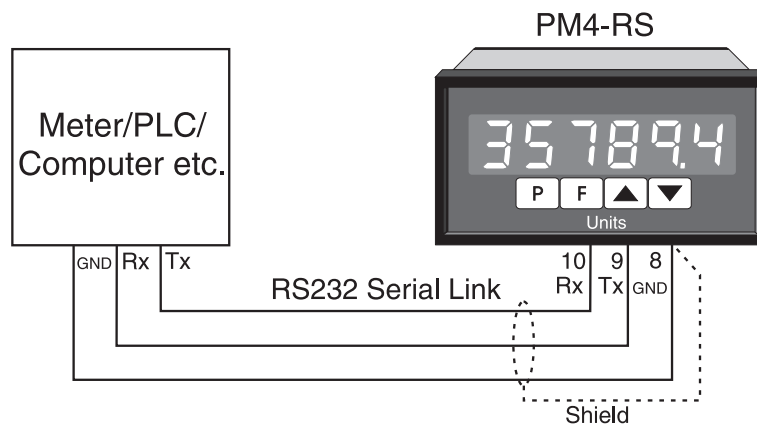

2.3 RS485 connections

RS485 connections use shielded, twisted pair wires. RS485 is rated to a maximum cable length of approximately 1200 metres and will allow connection of up to 32 drivers or receivers on the serial link. For cable runs of longer than a few metres terminating resistors may be required across the A and B terminals. The PM4-RS has an internal link (LK3) which can be used to switch in or out of circuit a 150Ω terminating resistor. For units without internal terminating resistors an external resistor of 150Ω (nominal) may be fitted. The terminating resistors are only required at the first and last units on the link.

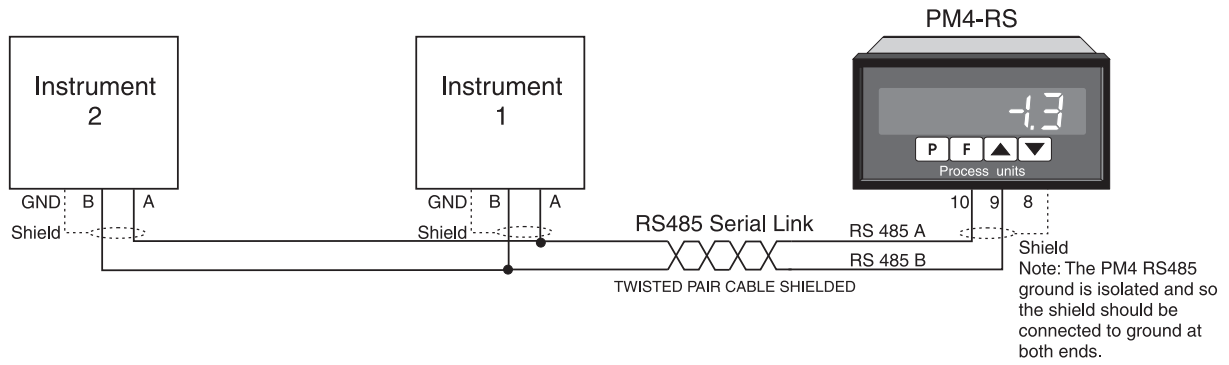

2.4 RS422 connections

RS422 connections use twin twisted pair, overall screened cable. RS422 is rated to a maximum cable length of approximately 1200 metres and will allow connection of 1 driver and up to 10 receivers on the serial link. Internal terminating resistors for RS422 can be fitted via links LK3 and LK4, see RS485 section above for notes on terminating links.

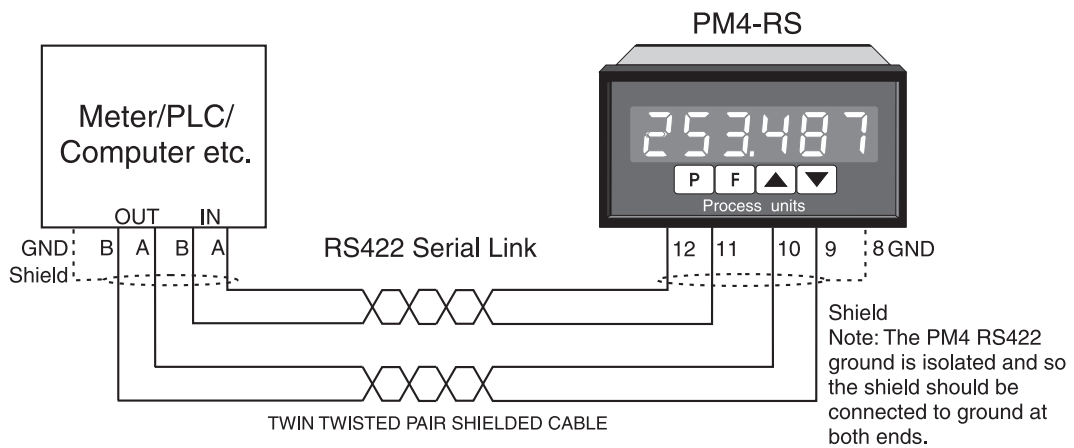

2.5 Serial current loop connections

Serial (i.e. pulsed) 20mA current loop connections are as shown below.

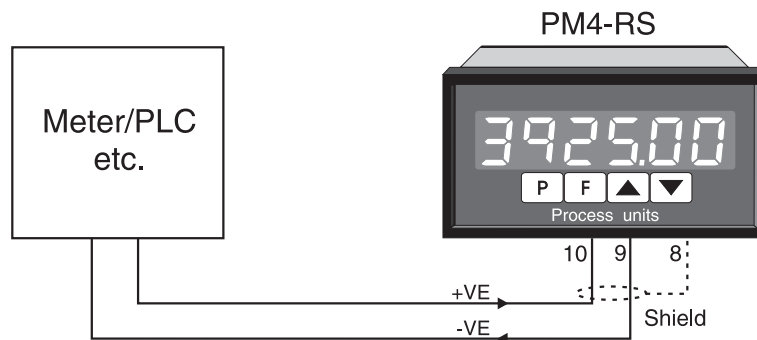



2.6 Relay connections

Relay connections The PM4 is supplied with one alarm relay as standard with connections on terminals 5 and 6, extra relays are optionally available. The relay is a single pole, single throw type and is rated at 5A, 240VAC into a resistive load. The relay contact is voltage free and may be programmed for normally open or normally closed operation.

2.7 Ext In (Remote input) connections

To operate the remote input connect a voltage free switch or relay across terminals 7 and 8. The function selected at the **F.I NP** function will operate when the switch is closed. Choose a momentary or latching switch to suit the application selected.

2.8 Wiring to WS-MMW-005 wind speed and direction sensor

WS-MMW-005 wind speed/direction sensor - connections to PM4-RS Note: Sensor can be connected as RS232 or RS485, baud rate 4800, Parity none, 8 bit data, **Code** function set to **AREA**. The  or  button can be used to toggle between wind speed and direction display.

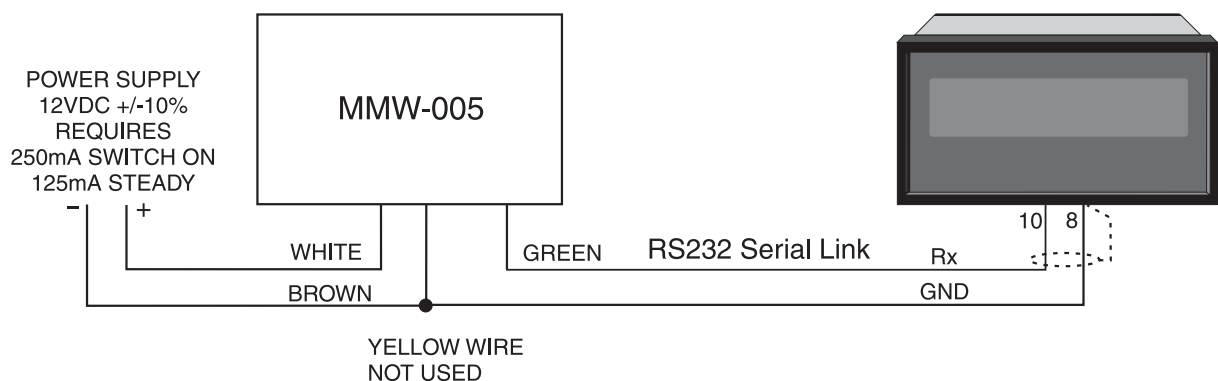
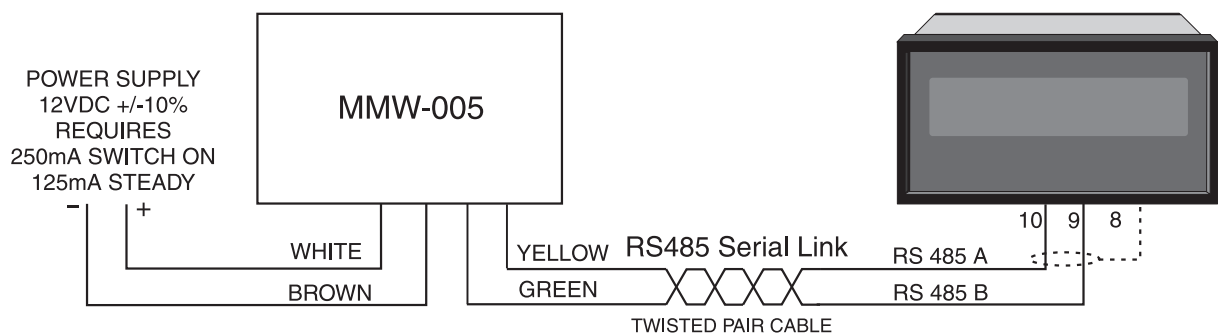

2.9 Link and driver chip connections

The driver chips are factory installed for the configuration ordered.

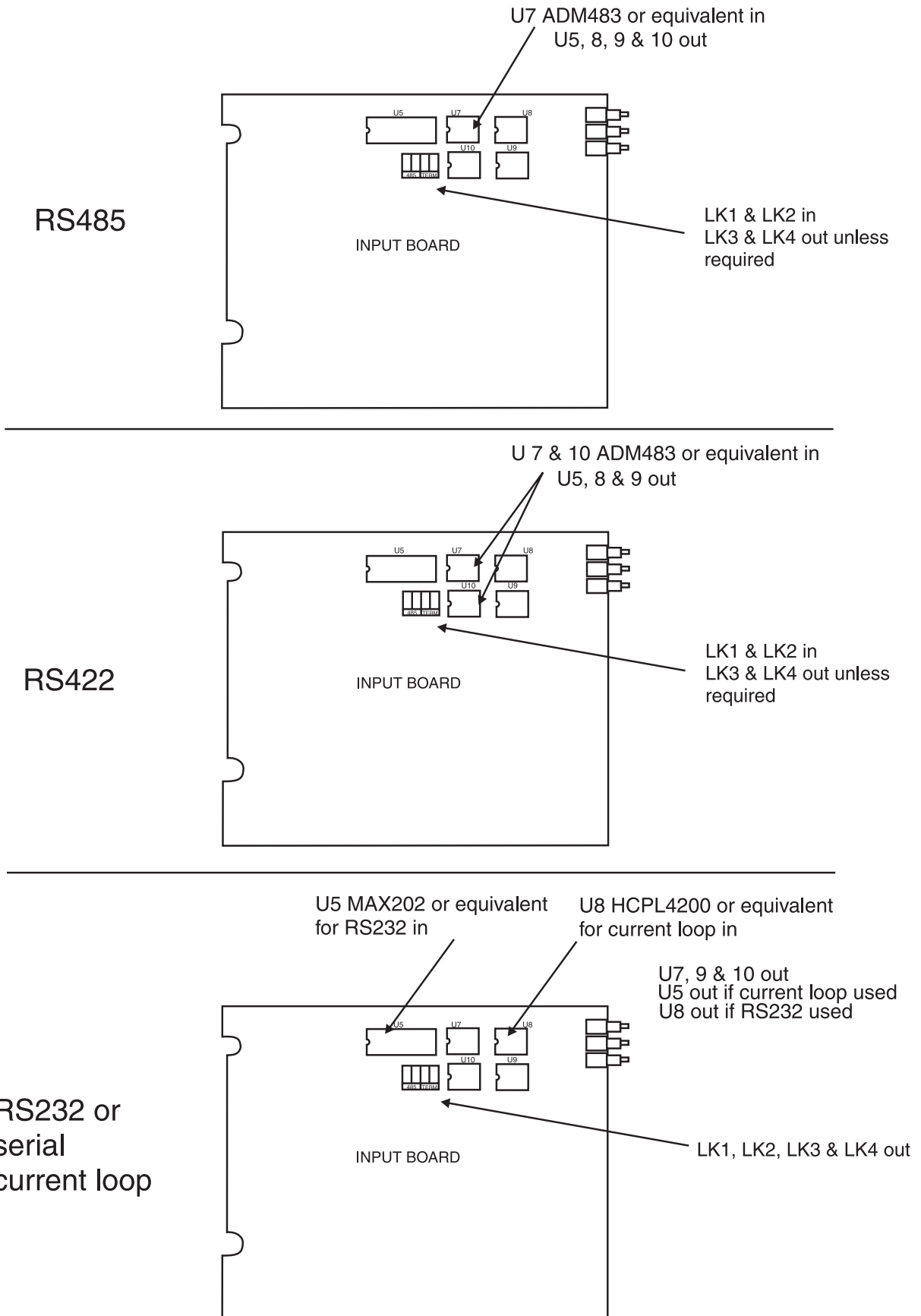

3 Function tables - Arithmetic mode

Note: the order in which the functions appear on the display may not be exactly as shown below. The availability and order of functions is determined by choice of function settings and options fitted.

Functions in this first table are available in **FUNC** or **CAL** mode

Display	Function	Range	Default	Your record	Ref/Page
AxLo	Low setpoint value for designated alarm relay <i>x</i>	Any display value or OFF	OFF	See 6.1	4.1 / 18
AxH	High setpoint value for designated alarm relay <i>x</i>	Any display value or OFF	OFF	See 6.1	4.2 / 18
AxHY	Hysteresis value for the designated alarm relay <i>x</i> .	0 to 9999	10	See 6.1	4.3 / 19
Axtt	Trip time delay for the designated alarm relay <i>x</i> .	0 to 9999	0	See 6.1	4.4 / 20
Axrt	Reset time delay for the designated alarm relay <i>x</i> .	0 to 9999	0	See 6.1	4.5 / 20
Axn.o or Axn.c	Alarm relay <i>x</i> action to normally open (de-energised) or normally closed (energised)	Axn.o or Axn.c	Axn.o	See 6.1	4.6 / 20
AxSP or Axt i etc.	Relay operation independent setpoint or trailing setpoint (*Optional)	AxSP or Axt i etc.	AxSP	See 6.1	4.7 / 21
brgt	Display brightness level	1 to 15	15		4.8 / 21
dull	Display remote brightness switching	0 to 15	1		4.9 / 21

(*Optional)—this function will only be accessible if the relevant option is fitted

Functions in this second table are available only in **CAL** mode or if **ACCS** is set to **ALL**

Display	Function	Range	Default	Your record	Ref/Page
bar-	Bargraph low value	Any display value	0		4.10 / 22
bar⁺	Bargraph high value	Any display value	1000		4.11 / 22
bar TYPE	Bargraph type for instruments with bargraph display	bar , S.dot , d.dot , C.bAR or r.dot	bar		4.12 / 22

(*Optional)—this function will only be accessible if the relevant option is fitted

bAr CHAN	Bargraph channel	0 to 8	0		4.13 / 23
FEC₋	Analog output option low display value (* Optional)	Any display value	0		4.14 / 24
FEC⁻	Analog output option high display value (* Optional)	Any display value	1000		4.15 / 24
rEC	Analog output 1 channel (* Optional)	ch0 to ch8	ch0		4.16 / 24
FEC₋ Ch2	Second analog output option low display value (* Optional)	Any display value	0		4.17 / 25
FEC⁻ Ch2	Second analog output option high display value (* Optional)	Any display value	1000		4.18 / 25
rEC2	Analog output 2 channel (* Optional)	ch0 to ch8	ch0		4.19 / 25
drnd	Display rounding	1 to 5000	1		4.20 / 25
dCPt	Decimal point	0, 0.1 etc.	0		4.21 / 26
FLtr	Digital filter	0 to 8	2		4.22 / 26
Arth CH	Number of active channels for Arth mode	1 to 8	4		4.48 / 35
Ch1 Addr	Channel 1 address	P1 to P8 or S1 to S8 or t1 to t8	P1		4.49 / 36
Ch2 Addr	Channel 2 address	P1 to P8 or S1 to S8 or t1 to t8	P1		4.50 / 36
Ch3 Addr	Channel 3 address	P1 to P8 or S1 to S8 or t1 to t8	P1		4.51 / 36
Ch4 Addr	Channel 4 address	P1 to P8 or S1 to S8 or t1 to t8	P1		4.52 / 36
Ch5 Addr	Channel 5 address	P1 to P8 or S1 to S8 or t1 to t8	P1		4.53 / 37
Ch6 Addr	Channel 6 address	P1 to P8 or S1 to S8 or t1 to t8	P1		4.54 / 37
Ch7 Addr	Channel 7 address	P1 to P8 or S1 to S8 or t1 to t8	P1		4.55 / 37

(***Optional**)—this function will only be accessible if the relevant option is fitted

Ch8 Addr	Channel 8 address	P1 to P8 or S1 to S8 or E1 to E8	P1		4.56 / 37
Ch1 dCPE	Channel 1 decimal point	0, 0.1 etc.	0		4.57 / 37
Ch2 dCPE	Channel 2 decimal point	0, 0.1 etc.	0		4.58 / 38
Ch3 dCPE	Channel 3 decimal point	0, 0.1 etc.	0		4.59 / 38
Ch4 dCPE	Channel 4 decimal point	0, 0.1 etc.	0		4.60 / 38
Ch5 dCPE	Channel 5 decimal point	0, 0.1 etc.	0		4.61 / 38
Ch6 dCPE	Channel 6 decimal point	0, 0.1 etc.	0		4.62 / 38
Ch7 dCPE	Channel 7 decimal point	0, 0.1 etc.	0		4.63 / 39
Ch8 dCPE	Channel 8 decimal point	0, 0.1 etc.	0		4.64 / 39
EA1	EA1 value for arithmetic formula	-32767 to 32767	1		4.65 / 39
EB1	EB1 value for arithmetic formula	-32767 to 32767	0		4.66 / 40
EC2	EC2 value for arithmetic formula	-32767 to 32767	1		4.70 / 40
EA2	EA2 value for arithmetic formula	-32767 to 32767	1		4.68 / 40
EB2	EB2 value for arithmetic formula	-32767 to 32767	0		4.69 / 40
EC2	EC2 value for arithmetic formula	-32767 to 32767	1		4.70 / 40
EA3	EA3 value for arithmetic formula	-32767 to 32767	1		4.71 / 41
EB3	EB3 value for arithmetic formula	-32767 to 32767	0		4.72 / 41
EC3	EC3 value for arithmetic formula	-32767 to 32767	1		4.73 / 41
EA4	EA4 value for arithmetic formula	-32767 to 32767	1		4.74 / 41
EB4	EB4 value for arithmetic formula	-32767 to 32767	0		4.75 / 41

(*Optional)—this function will only be accessible if the relevant option is fitted

EC4	EC4 value for arithmetic formula	-32727 to 32767	1		4.76 / 42
EAS	EAS value for arithmetic formula	-32727 to 32767	1		4.77 / 42
Eb5	Eb5 value for arithmetic formula	-32727 to 32767	0		4.78 / 42
ECS	ECS value for arithmetic formula	-32727 to 32767	1		4.79 / 42
EAB6	EAB6 value for arithmetic formula	-32727 to 32767	1		4.80 / 42
Eb6	Eb6 value for arithmetic formula	-32727 to 32767	0		4.81 / 43
EC6	EC6 value for arithmetic formula	-32727 to 32767	1		4.82 / 43
EAT7	EAT7 value for arithmetic formula	-32727 to 32767	1		4.83 / 43
Eb7	Eb7 value for arithmetic formula	-32727 to 32767	0		4.84 / 43
EC7	EC7 value for arithmetic formula	-32727 to 32767	1		4.85 / 43
EAB8	EAB8 value for arithmetic formula	-32727 to 32767	1		4.86 / 44
Eb8	Eb8 value for arithmetic formula	-32727 to 32767	0		4.87 / 44
EC8	EC8 value for arithmetic formula	-32727 to 32767	1		4.88 / 44
Ch1	Channel 1 polarity	both, POS or NEG	both		4.89 / 44
Ch2	Channel 2 polarity	both, POS or NEG	both		4.90 / 45
Ch3	Channel 3 polarity	both, POS or NEG	both		4.91 / 45
Ch4	Channel 4 polarity	both, POS or NEG	both		4.92 / 45
Ch5	Channel 5 polarity	both, POS or NEG	both		4.93 / 45
Ch6	Channel 6 polarity	both, POS or NEG	both		4.94 / 45
Ch7	Channel 7 polarity	both, POS or NEG	both		4.95 / 46

(*Optional)—this function will only be accessible if the relevant option is fitted

Ch8	Channel 8 polarity	both, POS or NEG	both		4.96 / 46
OP1	Arithmetic operation between channels 1 and 2	Add, Sub, Prod, d, U, H, 9h, Lo, SI NE, COS or C.Sub	Add		4.97 / 46
OP2	Arithmetic operation between channel 3 and previous operation	Add, Sub, Prod, d, U, H, 9h, Lo, SI NE or COS	Add		4.98 / 47
OP3	Arithmetic operation between channel 4 and previous operation	Add, Sub, Prod, d, U, H, 9h, Lo, SI NE or COS	Add		4.99 / 47
OP4	Arithmetic operation between channel 5 and previous operation	Add, Sub, Prod, d, U, H, 9h, Lo, SI NE or COS	Add		4.100 / 48
OP5	Arithmetic operation between channel 6 and previous operation	Add, Sub, Prod, d, U, H, 9h, Lo, SI NE or COS	Add		4.101 / 48
OP6	Arithmetic operation between channel 7 and previous operation	Add, Sub, Prod, d, U, H, 9h, Lo, SI NE or COS	Add		4.102 / 49
OP7	Arithmetic operation between channel 8 and previous operation	Add, Sub, Prod, d, U, H, 9h, Lo, SI NE or COS	Add		4.103 / 49
BAUD RATE	Baud rate for serial communications	300.600. 1200.2400. 4800.9600. 19.2 or 38.4	9600		4.26 / 27
Prty	Parity for serial input	NONE.EVEN or Odd	NONE		4.27 / 27
DATA	Data type	8.b, t or 7.b, t	8.b, t		4.28 / 27
INPUT	Input type	r232, r422, r485 or 120	r232		4.29 / 28

(*Optional)—this function will only be accessible if the relevant option is fitted

Code	Data type for display	di SP, ASCII, UAL, AFtH, n.buS, PkR, SCAR, nAER or CS	di SP		4.30 / 28
A1 OPEr	Alarm relay 1 operation mode	i NPE, t.out or both	i NPE		4.31 / 30
A2 OPEr	Alarm relay 2 operation mode	i NPE, t.out or both	i NPE		4.32 / 30
dS.t0	Display timeout	0 to 9999	10		4.33 / 30
t.out	Data string timeout	0.0 to 10.0	1.0		4.34 / 31
FAST r485	Fast RS485	on or OFF	OFF		4.35 / 31
d9OP	Digital output option mode (*Optional)	bcd, b.SCL, bi, n or bi, n2	bi, n2		4.36 / 31
d9.OP	Digital output option polarity (*Optional)	Hi o or AH,	Hi o		4.37 / 31
bcd Start	Digital output option BCD start position (*Optional)	0, 1 or 2	0		4.38 / 32
d, 9-	Digital output option low value (*Optional)	Any display value	0		4.39 / 32
d, 9+	Digital output option high value (*Optional)	Any display value	1000		4.40 / 32
dout CHAN	Digital output option channel (*Optional)	ch0 to ch8	ch0		4.41 / 32
P.but	P button function	NONE, Hi, Lo, Hi Lo, tARE or zEFO	NONE		4.42 / 33
r, i NP	Remote input (external input) one function	NONE, P.HLd, d.HLd, Hi, Lo, Hi, Lo, tARE, zEFO, SP.Ac, No.Ac or duLL	NONE		4.43 / 33
ACCESS	Access mode	OFF, EASY, NONE or ALL	OFF		4.44 / 34
SPAC	Setpoint access mode (*Optional)	A1, A1-2 etc.	A1		4.45 / 34
A1	Alarm relay 1 operation channel	ch0 to ch8	ch0		4.46 / 35

(*Optional)—this function will only be accessible if the relevant option is fitted

A2 to A7	Alarm relays 2 to 7 operation channel (*Optional)	ch0 to ch8	ch0		4.47 / 35
CLR ZERO	Clear zero	n/a	n/a		4.104 / 50
F.tnn bAUD	Baud rate for serial retransmission (*Optional)	300, 600, 1200, 2400, 4800, 9600, 19.2 or 38.4	9600		4.105 / 50
F.tnn Prty	Parity for serial retransmission (*Optional)	NONE, EVEN or Odd	NONE		4.106 / 51
F.tnn O.Put	Output mode for serial retransmission (*Optional)	NONE, di SP, Cont, POLL, Cont, n.bus or A.bus	NONE		4.107 / 51
F.tnn Addr	Address for serial retransmission (*Optional)	0 to 31	0		4.108 / 51

(*Optional)—this function will only be accessible if the relevant option is fitted

3.1 Relay table

Record your relay settings in the table below

Display	Relay 1	Relay 2	Relay 3	Relay 4	Relay 5	Relay 6	Relay 7
RxLo							
RxH,							
RxHY							
Rxtt							
Rxrt							
Rxn.o or Rxn.c							
RxSP or Rxt 1 etc.	n/a						
A1							
A2							
A3							
A4							
A5							
A6							
A7							

4 Arithmetic and Wind Speed/Direction mode functions

Some of the functions described in this chapter are common to both **ARFM** and **ARER** modes, others will only appear in one mode, check the function tables for each mode to confirm which functions apply. The PM4 setup and calibration functions are configured through a push button sequence. The three push buttons located at the rear of the instrument (also at the front on some display options) are used to alter settings. Two basic access modes are available:

FUNC mode (simple push button sequence) allows access to commonly set up functions such as alarm setpoints.

CAL mode (power up sequence plus push button sequence) allows access to all functions including calibration parameters.

Once **CAL** or **FUNC** mode has been entered you can step through the functions, by pressing and releasing the **F** push button, until the required function is reached. Changes to functions are made by pressing the **▲** or **▼** push button (in some cases both simultaneously) when the required function is reached. See the flow chart example on the following page.

Entering **CAL** Mode



1. Remove power from the instrument. Hold in the **F** button and reapply power. The display will briefly indicate **CAL** as part of the "wake up messages" when the **CAL** message is seen you can release the button. Move to step 2 below.



2. When the "wake up" messages have finished and the display has settled down to its normal reading press, then release the **F** button. Move to step 3 below.

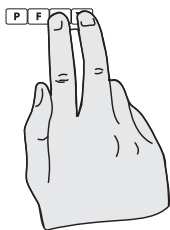

3. Within 2 seconds of releasing the **F** button press, then release the **▲** and **▼** buttons together. The display will now indicate **FUNC** followed by the first function.

Note: If step 1 above has been completed then the instrument will remain in this **CAL** mode state until power is removed. i.e. there is no need to repeat step 1 when accessing function unless power has been removed.

Entering **FUNC** Mode

No special power up procedure is required to enter **FUNC** mode.



1. When the "wake up" messages have finished and the display has settled down to its normal reading press, then release the **F** button.



2. Within 2 seconds of releasing the **F** button press, then release the **▲** and **▼** buttons together. The display will now indicate **FUNC** followed by the first function.

Example: Entering **FUNC** mode to change alarm 1 high function **ALH**, from **OFF** to **100**

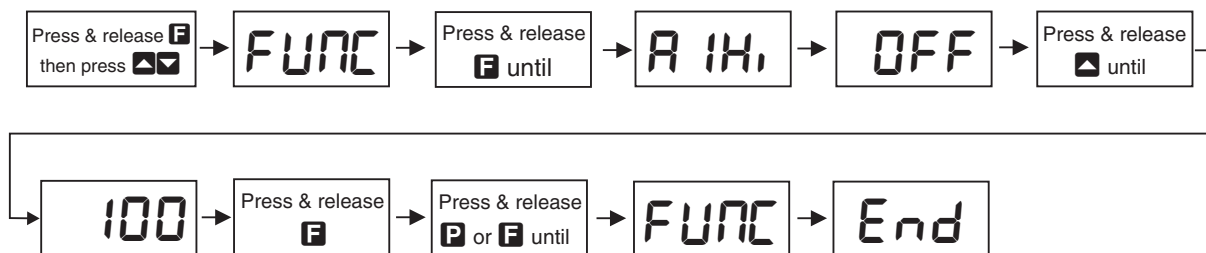

Example: Entering **CAL** mode to change decimal point function **dCPT** from **0** to **0.02**

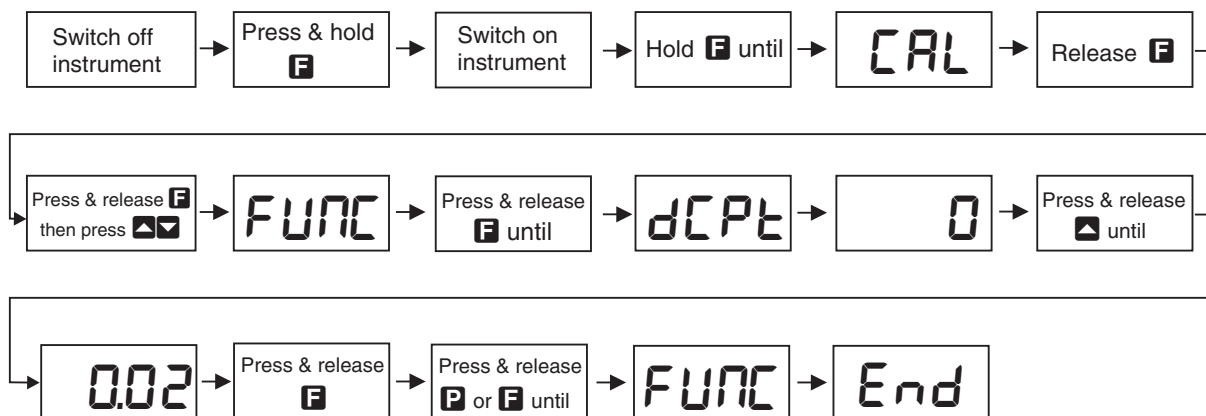

Easy alarm relay adjustment access facility

The display has an easy alarm access facility which allows access to the alarm setpoints simply by pressing the **F** button at the front or rear of the instrument. The first setpoint will then appear and changes to this setpoint may be made to this setpoint via the **▲** or **▼** buttons. Press the **F** button to accept any changes or to move on to the next setpoint. Note: this easy access also functions in the same manner for the PI control setpoint (relay and/or analog PI output) if PI control is available. The instrument must be set in the manner described below to allow the easy access facility to work:

1. The **F: NP** function must be set to **SPAC** or the **ACCS** function must be set to **EASY**.
2. At least one alarm must have a setpoint, nothing will happen if all the alarm setpoints are set to **OFF**.
3. The **SPAC** function must be set to allow access to the relays required e.g. if set to **A 1-2** then the easy access will work only with alarm relays 1 and 2 even if more relays are fitted.
4. The instrument must be in normal measure mode i.e. if the instrument is powered up so that it is in **CAL** mode then the easy access will not function. If in doubt remove power from the instrument, wait for a few seconds then apply power again.
5. If the easy access facility is used then the only way to view or alter any other function settings is to power up via **CAL** mode i.e. there is no entry to **FUNC** mode functions unless the instrument is powered up in **CAL** mode.

4.1 Alarm relay low setpoint

Display: $RxLo$
Range: Any display value or **OFF**
Default Value: **OFF**

Displays and sets the low setpoint value for the designated alarm relay x . Note x will be replaced by the relay number when displayed e.g. $R1Lo$ for relay 1. Use this low setpoint function if a relay operation is required when the display value becomes equal to or less than the low setpoint value. To set a low alarm value go to the $RxLo$ function and use the \blacktriangle or \blacktriangledown push buttons to set the value required then press **F** to accept this value. The low alarm setpoint may be disabled by pressing the \blacktriangle and \blacktriangledown push buttons simultaneously. When the alarm is disabled the display will indicate **OFF**. If the relay is allocated both a low and high setpoint then the relay will activate when the value displayed moves outside the band set by the low and high setpoints. The value at which the relay will reset is controlled by the $RxHy$ function.

Example:

If $R1Lo$ is set to **10** then relay 1 will activate when the display value is 10 or less.

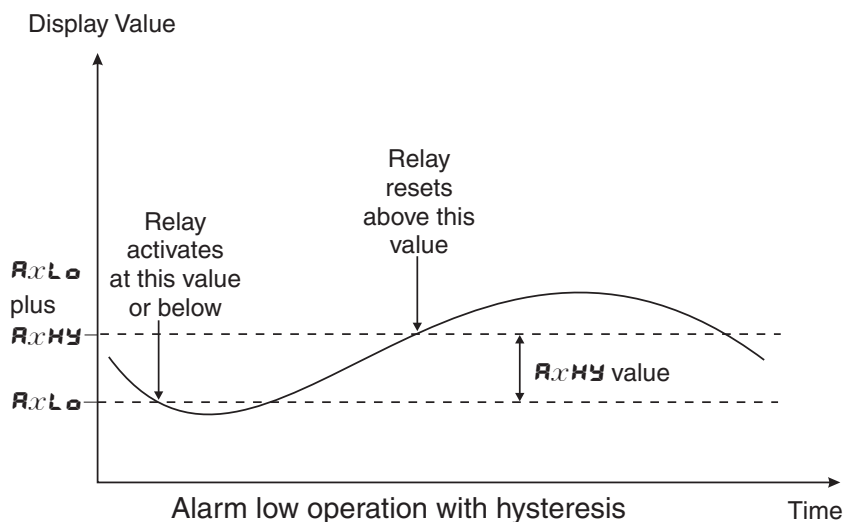

4.2 Alarm relay high setpoint

Display: RxH
Range: Any display value or **OFF**
Default Value: **OFF**

Displays and sets the high setpoint value for the designated alarm relay x . Note x will be replaced by the relay number when displayed e.g. $R1H$ for relay 1. Use this high setpoint function if a relay operation is required when the display value becomes equal to or more than the low setpoint value. To set a high alarm value go to the RxH function and use the \blacktriangle or \blacktriangledown push buttons to set the value required then press **F** to accept this value. The high alarm setpoint may be disabled by pressing the \blacktriangle and \blacktriangledown push buttons simultaneously. When the alarm is disabled the display will indicate **OFF**. If the relay is allocated both a low and high setpoint then the relay will activate when the value displayed moves outside the band set by the low and high setpoints. The value at which the relay will reset is controlled by the $RxHy$ function.

Example:

If **A 1H** is set to **100** then relay 1 will activate when the display value is **100** or higher.

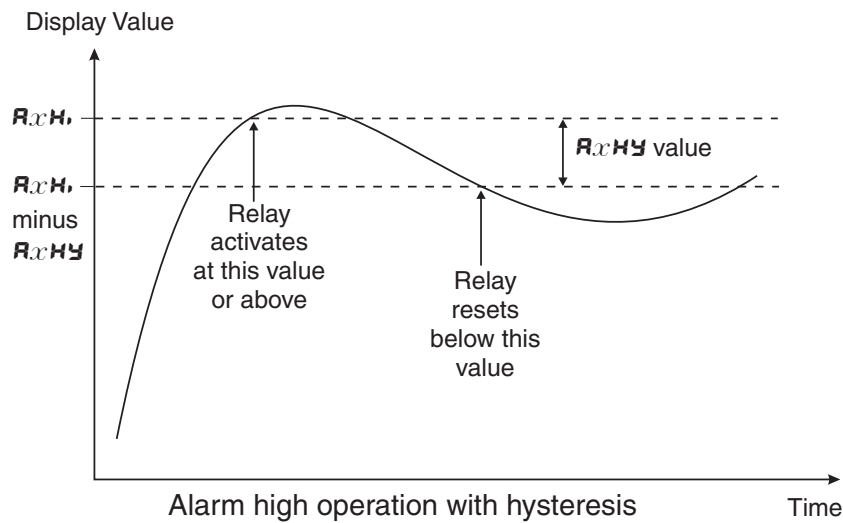

4.3 Alarm relay hysteresis (deadband)

Display: **AxHY**
Range: **0** to **9999**
Default Value: **10**

Displays and sets the alarm relay hysteresis limit for the designated relay x . Note x will be replaced by the relay number when displayed e.g. **A 1HY** for relay 1. To set a relay hysteresis value go to the **AxHY** function and use the **▲** or **▼** push buttons to set the value required then press **F** to accept this value. The hysteresis value is common to both high and low setpoint values. The hysteresis value may be used to prevent too frequent operation of the relay when the measured value is rising and falling around setpoint value. e.g. if **A 1HY** is set to zero the alarm will activate when the display value reaches the alarm setpoint (for high alarm) and will reset when the display value falls below the setpoint, this can result in repeated on/off switching of the relay at around the setpoint value.

The hysteresis setting operates as follows: In the high alarm mode, once the alarm is activated the input must fall below the setpoint value minus the hysteresis value to reset the alarm. e.g. if **A 1H** is to **50.0** and **A 1HY** is set to **3.0** then the setpoint output relay will activate once the display value goes to **50.0** or above and will reset when the display value goes below **47.0** i.e. at **46.9** or below. In the low alarm mode, once the alarm is activated the input must rise above the setpoint value plus the hysteresis value to reset the alarm. e.g. if **A 1Lo** is to **20.0** and **A 1HY** is set to **10.0** then the alarm output relay will activate when the display value falls to **20.0** or below and will reset when the display value goes above **30.0** i.e. at **30.1** or above. The hysteresis units are expressed in displayed engineering units.

Example: If **A 1H** is set to **100** and **A 1HY** is set to **10** then relay 1 will activate when the display value is **100** or higher and will reset at a display value of **89** or lower.

4.4 Alarm relay trip time

Display: **Ax.t.t**
Range: **0** to **9999**
Default Value: **0**

Displays and sets the alarm trip time in seconds. The trip time is common for both alarm high and low setpoint values. The trip time provides a time delay before the alarm relay will activate when an alarm condition is present. The alarm condition must be present continuously for the whole trip time period before the alarm will activate. If the input moves out of alarm condition during this period the timer will reset and the full time delay will be restored. This trip time delay is useful for preventing an alarm trip due to short non critical deviations from setpoint. The trip time is selectable over **0** to **9999** seconds. To set a trip time value go to the **Ax.t.t** function and use the **▲** or **▼** push buttons to set the value required then press **F** to accept this value.

Example: If **A 1.t.t** is set to **5** seconds then the display must indicate an alarm value for a full 5 seconds before relay 1 will activate.

4.5 Alarm relay reset time

Display: **Ax.r.t**
Range: **0** to **9999**
Default Value: **0**

Displays and sets the alarm reset delay time in seconds. The reset time is common for both alarm high and low setpoint values. With the alarm condition is removed the alarm relay will stay in its alarm condition for the time selected as the reset time. If the input moves back into alarm condition during this period the timer will reset and the full time delay will be restored. The reset time is selectable over **0** to **9999** seconds. To set a reset time value go to the **Ax.r.t** function and use the **▲** or **▼** push buttons to set the value required then press **F** to accept this value.

Example: If **A 1.r.t** is set to **10** seconds then the resetting of alarm relay 1 will be delayed by 10 seconds.

4.6 Alarm relay normally open/closed

Display: **Ax.n.o** or **Ax.n.c**
Range: **Ax.n.o** or **Ax.n.c**
Default Value: **Ax.n.o**

Displays and sets the setpoint alarm relay *x* action to normally open (de-energised) or normally closed (energised), when no alarm condition is present. Since the relay will always open when power is removed a normally closed alarm is often used to provide a power failure alarm indication. To set the alarm relay for normally open or closed go to the **Ax.n.o** or **Ax.n.c** function and use the **▲** or **▼** push buttons to set the required operation then press **F** to accept this selection. **Example:** If set to **A 1.n.o** alarm relay 1 will be open circuit when the display is outside alarm condition and will be closed (short circuit across terminals) when the display is in alarm condition.

4.7 Alarm relay setpoint or trailing operation

Display: **$AxSP$** or **$Ax.t.1$** etc.

Range: **$AxSP$** or **$Ax.t.1$** etc.

Default Value: **$AxSP$**

Relay operation independent setpoint or trailing setpoint, this function will not be seen unless extra optional relays are fitted. Each alarm, except relay 1, may be programmed to operate with an independent setpoint value or may be linked to operate at a fixed difference to another relay setpoint, known as trailing operation. The operation is as follows:

Alarm 1 (**A1**) is always independent. Alarm 2 (**A2**) may be independent or may be linked to Alarm 1. Alarm 3 (**A3**) may be independent or may be linked to Alarm 1 or Alarm 2. Alarm 4 (**A4**) may be independent or may be linked to Alarm 1, Alarm 2 or Alarm 3. The operation of each alarm is selectable by selecting, for example, (Alarm 4) **A4.SP** = Alarm 4 normal setpoint or **A4.t.1** = Alarm 4 trailing Alarm 1 or **A4.t.2** = Alarm 4 trailing Alarm 2 or **A4.t.3** = Alarm 4 trailing Alarm 3. For trailing set points the setpoint value is entered as the difference from the setpoint being trailed. If the trailing setpoint is to operate ahead of the prime setpoint then the value is entered as a positive number and if operating behind the prime setpoint then the value is entered as a negative number.



Example: With Alarm 2 set to trail alarm 1, if **A1H** is set to **1000** and **A2H** is set to **50** then Alarm 1 will activate at **1000** and alarm 2 will activate at **1050** (i.e. 1000 + 50). If Alarm 2 had been set at **-50** then alarm 2 would activate at **950** (i.e. 1000 - 50).

4.8 Display brightness

Display: **br9t**

Range: **1** to **15**

Default Value: **15**

Displays and sets the digital display brightness. The display brightness is selectable from **1** to **15**, where **1** = lowest intensity and **15** = highest intensity. This function is useful for improving the display readability in dark areas or to reduce the power consumption of the instrument. See also the **dull** function. To set brightness level go to the **br9t** function and use the  or  push buttons to set the value required then press  to accept this value.

4.9 Display remote brightness switching

Display: **dull**

Range: **0** to **15**

Default Value: **1**

Displays and sets the level for remote input brightness switching, see **r.inp** function. When a remote input is set to **dull** the remote input can be used to switch between the display brightness level set by the **br9t** function 4.8 and the display brightness set by the **dull** function. The display dull level is selectable from **0** to **15**, where **0** = lowest intensity and **15** = highest intensity. This function is useful in reducing glare when the display needs to be viewed in both light and dark

ambient light levels. To set dull level go to the **dULL** function and use the ▲ or ▼ push buttons to set the value required then press **F** to accept this value.

Example:

With **dULL** set to **4** and **br9t** set to **15** and the **F.I.N.P** function set to **dULL** the display brightness will change from the **15** level to **4** when a switch connected to the remote input terminals is activated.

4.10 Bargraph low value

Display: **bAr_**
Range: Any display value
Default Value: **0**

Seen only in bargraph display instruments. Displays and sets the bar graph low value i.e. the value on the 7 segment display at which the bargraph will start to rise. This may be independently set anywhere within the display range of the instrument. Note: The **bAr_** and **bAr^** settings are referenced from the 7 segment display readings, not the bargraph scale values. The bargraph scale may scaled differently to the 7 segment display. For example the bargraph scale may be indicating percentage fill of a tank whilst the 7 segment display is indicating actual process units. To set bargraph low level go to the **bAr_** function and use the ▲ or ▼ push buttons to set the value required then press **F** to accept this value.

4.11 Bargraph high value

Display: **bAr^**
Range: Any display value
Default Value: **1000**

Seen only in bargraph display instruments. Displays and sets the bar graph high value i.e. the value on the 7 segment display at which the bargraph will reach its maximum indication (e.g. all LEDs illuminated). May be independently set anywhere within the display range of the instrument. To set bargraph high level go to the **bAr^** function and use the ▲ or ▼ push buttons to set the value required then press **F** to accept this value.

4.12 Bargraph type for instruments with bargraph display

Display: **bAr tYPE**
Range: **bAr**, **S.dot**, **d.dot**, **C.bAr** or **r.dot**
Default Value: **bAr**

Bar graph display operation mode - seen only in vertical or circular bargraph display instruments. Allows selection of bargraph operation mode. Choices available are:

- **bAr** - conventional solid bargraph display i.e. all LEDs illuminated when at full scale. When scaling the display use the **bAr_** and **bAr^** functions e.g. **bAr_ = 0** and **bAr^ =**

100 will give a bargraph with no segments lit at a 7 segment display reading of **0** and all segments lit with a 7 segment display reading of **100**.

- **S.dot** - single dot display. A single segment will be lit to indicate the input readings position on the scale. When scaling the display use the **bAr_L** and **bAr_R** functions e.g. **bAr_L = 0** and **bAr_R = 100** will give a bargraph with the bottom segment lit at a 7 segment display reading of **0** and the top segment lit with a 7 segment display reading of **100**. Note: this could also be set up as a centre zero single dot display by entering a negative value and positive value. e.g. **bAr_L = -100, bAr_R = 100**.
- **d.dot** - double dot display. Two segments will be lit to indicate the input reading position on the scale. The reading should be taken from the middle of the two segments. When scaling the display use the **bAr_L** and **bAr_R** functions e.g. **bAr_L = 0** and **bAr_R = 100** will give a bargraph with the bottom two segments lit at a 7 segment display reading of **0** and the top two segments lit with a 7 segment display reading of **100**. Note: this could also be set up as a centre zero double dot display by entering a negative value and positive value. e.g. **bAr_L = -100, bAr_R = 100**.
- **C.bAr** - centre bar display. The display will be a solid bargraph but will have its zero point in the middle of the display. If the seven segment display value is positive the bargraph will rise. If the seven segment display value is negative then the bargraph will fall. When scaling the display use the **bAr_L** and **bAr_R** functions e.g. **bAr_L = 0** and **bAr_R = 100** will give a bargraph with all the bottom half segments lit at a 7 segment display reading of **-100** and all the top segments lit with a 7 segment display reading of **100**.
- **r.dot** - modulus or wrap around single dot bargraph. This mode of operation allows the bargraph to wrap around the limits set by the **bAr_L** and **bAr_R** functions by dividing the 7 segment display by the modulus (the modulus is the difference between 0 and **bAr_R**) and displaying the remainder. For example if **bAr_L** is set to **0** and **bAr_R** is set to **10** then in other bargraph modes when the 7 segment display reads a value such as **25** the bargraph would be stuck at the high limit of its travel since it cannot go beyond **10**. In **r.dot** mode the display will wrap around at **10** then continue up the bar again and will be at the midpoint of the bargraph when the 7 segment display shows **25** (as it would for a 7 segment display of **15, 35**, etc.). In this example for a 7 segment display of **25** the value of 25 is divided by the modulus value of 10 in this example and the remainder displayed i.e. 10 goes into 25 twice with the remainder of 5 and so a bargraph position of 5 is displayed. This mode will operate on both vertical and circular bargraph type displays.

4.13 Bargraph channel

Display: **bAr CHAN**



Range: **0 to 8**

Default Value: **0**

Bargraph channel - for multiple input value modes e.g. **ARLH** mode, this function allows selection of which of the inputs will be sent to the bargraph for display. The first input will be displayed by the 7 segment display. For **ARER** mode channel is the wind direction and channel 2 is the wind speed.

4.14 Analog output option low value

Display: `FEC_`
Range: Any display value
Default Value: `0`



Seen only when analog retransmission option fitted. Refer to the separate “PM4 Panel Meter Optional Output Addendum” booklet supplied when this option is fitted for wiring details and link settings. Displays and sets the analog retransmission (4–20mA, 0–1V or 0–10V, link selectable) output low value (4mA or 0V) in displayed engineering units. To set the analog output low value go to the `FEC_` function and use the  or  push buttons to set the required value then press  to accept this selection.

Example:

If it is required to retransmit 4mA when the display indicates `0` then select `0` in this function using the  or  button.

4.15 Analog output option high value

Display: `FEC^`
Range: Any display value
Default Value: `1000`

Seen only when analog retransmission option fitted. Refer to the separate “PM4 Panel Meter Optional Output Addendum” booklet supplied when this option is fitted for wiring details and link settings. Displays and sets the analog retransmission (4–20mA, 0–1V or 0–10V, link selectable) output high display value (20mA, 1V or 10V) in displayed engineering units. To set the analog output high value go to the `FEC^` function and use the  or  push buttons to set the required value then press  to accept this selection.

Example:

If it is required to retransmit 20mA when the display indicates `50` then select `50` in this function using the  or  button.

4.16 Analog output 1 channel

Display: `rEC`
Range: `ch0` to `ch8`
Default Value: `ch0`

Seen only when analog retransmission option fitted. Refer to the separate “PM4 Panel Meter Optional Output Addendum” booklet supplied when this option is fitted for wiring details and link settings. Analog output 1 channel. Select from `ch0` to `ch8`. In `ANEA` mode select `ch1` for wind direction retransmission and `ch2` for wind speed. In `Arth` mode `ch0` is the arithmetic sum. `ch0` should not be selected for any mode other than `Arth`.

4.17 Second analog output option low value

Display: `rEE- ch2`
Range: Any display value
Default Value: `0`

See `rEE-` function 4.14 for description of operation.

4.18 Second analog output option high value

Display: `rEE~ ch2`
Range: Any display value
Default Value: `1000`

See `rEE~` function 4.15 for description of operation.



4.19 Analog output 2 channel

Display: `rEE2`
Range: `ch0` to `ch8`
Default Value: `ch0`

Seen only when analog retransmission option fitted. Refer to the separate “PM4 Panel Meter Optional Output Addendum” booklet supplied when this option is fitted for wiring details and link settings. Analog output 2 channel. Select from `ch0` to `ch8`. In `AREA` mode select `ch1` for wind direction retransmission and `ch2` for wind speed. In `Arth` mode `ch0` is the arithmetic sum. `ch0` should not be selected for any mode other than `Arth`.

4.20 Display rounding

Display: `drnd`
Range: `1` to `5000`
Default Value: `1`

Displays and sets the display rounding value. This value may be set to 1 - 5000 displayed units. Display rounding is useful for reducing the instrument resolution without loss of accuracy in applications where it is undesirable to display to a fine tolerance. To set the display rounding value go to the `drnd` function and use the  or  push buttons to set the required value then press **F** to accept this selection.

Example:

If set to `10` the display values will change in multiples of 10 only i.e. display moves from `10` to `20` to `30` etc.

4.21 Decimal point

Display: **dCPE**
Range: **0, 0.1** etc.
Default Value: **0**

Displays and sets the decimal point. By pressing the **▲** or **▼** pushbutton at the **dCPE** function the decimal point position may be set. The display will indicate as follows: **0** (no decimal point), **0.1** (1 decimal place), **0.02** (2 decimal places), **0.003** (3 decimal places) and **0.0004** for display with more than 4 digits. Note if the decimal point is altered the display will need to be recalibrated and alarm etc. settings checked.

4.22 Digital filter

Display: **FLER**
Range: **0** to **8**
Default Value: **2**

Displays and sets the digital filter value. Digital filtering uses a weighted average method of determining the display value and is used for reducing display value variation due to short term interference. The digital filter range is selectable from **0** to **8**, where **0** = none and **8** = most filtering. Use **▲** or **▼** at the **FLER** function to alter the filter level if required. Note that the higher the filter setting the longer the display may take to reach its final value when the input is changed, similarly the relay operation and any output options will be slowed down when the filter setting is increased. To set the digital filter value go to the **FLER** function and use the **▲** or **▼** push buttons to set the required value then press **F** to accept this selection.

4.23 Units to be used for **NAEA** mode

Display: **SPEd Unit**
Range: **MS, MPH, hPH** or **knot**
Default Value: **MS**

Applicable to **NAEA** mode only. Select from the following choices: **MS** (metres/sec), **MPH** (miles/hour), **hPH** (kilometers/hour) or **knot** (knots).

4.24 Default display for **NAEA** mode

Display: **dFLt d: SP**
Range: **d, r, SPEd** or **SCAN**
Default Value: **SCAN**

Applicable to **NAEA** mode only. Select from the following choices: **d, r** (wind direction), **SPEd** (wind speed) or **SCAN** (automatically toggles display between direction and speed at the rate set by the **SCAN SECS** function). For example if this function is set to **d, r** then the operator will

need to push the **▲** or **▼** button to display speed, the display will then automatically revert back to direction after approximately 4 minutes.

4.25 Number of seconds between scans

Display: **SCAN SECS**
Range: **0** to **255**
Default Value: **0**

Seen only when **Code** function is set to **SCAN**, **CS** or **AREA**. Selects the number of seconds between channel scans or between wind speed and direction if **Code** function is set to **AREA**. The scan period can be set from 0 to 255 seconds. If set to 0 the display will not automatically scroll between channels and the **▲** or **▼** button must be used to change the channel displayed. Note the display will not automatically scan if it is in **CAL** mode.

4.26 Baud rate for optional serial communications

Display: **BAUD RATE**
Range: **300 . 600 . 1200 . 2400 . 4800 . 9600 . 19.2** or **38.4**
Default Value: **9600**

Select from **300 . 600 . 1200 . 2400 . 4800 . 9600 . 19.2** or **38.4** baud. This must be set to match the baud rate selected at the sending device.

4.27 Parity for serial input

Display: **PRTY**
Range: **NONE . EVEN** or **Odd**
Default Value: **NONE**

Select parity check to either **NONE**, **EVEN** or **Odd**. This must be set to match the parity selected at the sending device.

4.28 Data type

Display: **DATA**
Range: **8.b, t** or **7.b, t**
Default Value: **8.b, t**

Displays and selects the input data type. Select either **8.b, t** for 8 data bits plus 1 stop bit or **7.b, t** for 7 data bits plus 1 stop bit. This must be set to match the number of data bits of the sending device.

4.29 Input type

Display: **I NPE**
Range: **r232, r422, r485** or **I 20**
Default Value: **r232**

Select input type used RS232, RS422, RS485 or serial 20mA current loop. Choices appear as: **r232, r422, r485** or **I 20**. The hardware for the input type is factory configured and changing this function does not change the input type but it is important that this function matches the hardware setup.

4.30 Data type for display

Display: **Code**
Range: **dI SP, ASCII, UAL, ALPH, n.b.u.s, PEA, SCAN, NAEA** or **CS**
Default Value: **dI SP**

One of eight different display modes can be selected in this function, namely **dI SP, ASCII, UAL, ALPH, n.b.u.s, PEA, SCAN, NAEA** or **CS**. Note: see the separate Addendum booklet for details of arithmetic mode **ALPH** and Wind speed/direction **NAEA** operation. The **PEA** option is a special purpose function and is not described to this manual. See also the “Examples” section at the end of this chapter. Note that if the mode is altered it is necessary to switch the instrument off then on again to reset to the new mode.

- **dI SP mode**

With **dI SP** selected (image mode) the display expects to see an input in raw data format from another instrument. This mode is generally only used when the display is connected to an instrument from the same manufacturer. This mode is not used with any other source. The data format expected is: <ESC>Incccc

Where: <ESC> is 27 Dec or 1B Hex
I is the ASCII character “I”
n is the number of image characters to follow
cccc are the image characters in Hex. format

- **ASCII mode**

ASCII selects ASCII type input data, the input data will then be displayed without modification (see also **ALPH** function as this can also affect what is displayed). Displays of characters in **ALPH** mode are left justified. Any leading zeroes received will be visible in this mode e.g. data received such as 00873 will be displayed as **00873**.

- **UAL mode**



With **UAL** selected (numeric or value mode) the incoming characters will not be displayed unless they are numeric characters or a negative sign “-”, the characters will be read until a terminating character (see **chr**) is found. In circumstances, e.g. when terminating characters are not sent by the transmitting device, the instrument can be programmed to look for a constant transmitted character which occurs before to the required display values rather than at the end of the string. In this instance the **SCM** character can be used and the

display told to display a number of characters after this character (see **n.Chr** function). Once the **chr** or **SCHi** character is found the numeric value will be updated and displayed. If a non numeric character is found then the conversion will cease at that point. Note that ASCII control characters 00 Decimal (Null) to 31 Decimal (Unit Separator) will be ignored if they are seen as part of the string and will not cause the conversion to cease when encountered, they will however not be ignored if used as a start character (**SCHi**, **2** or **3**) or the terminating character set at the **chr** function. The numeric value is filtered after conversion the **FLtr** setting determines the level of filtering. Note: In **URL** mode any leading zeroes transmitted will be ignored e.g. data received such as -00345 will be displayed as **-345**.

- **PAR mode**

Not applicable to this instruction manual. Do not use this mode.

- **SCAN mode**

With **SCAN** selected the instrument can be made to scan and display in turn values from up to 8 other devices or channels from the same manufacturer. To operate in scan mode select the number of channels to scan at the **SCAN CH** function then select the automatic scanning period at the **SCAN SECS** function (the scanning period sets the time for the display automatic scrolling, note that the  or  button can also be used to manually scroll between channels) then set the address for each channel at the **Ch1Addr**, **Ch2Addr** etc. functions. The address choices are **P1.P2.P3.P4.P5.P6.P7.P8.S1.S2.S3.S4.S5.S6.S7** or **S8. A1 to A8** and **t1 to t8** are also choices but are only for use in polling channels 1 to 8 of a model TP488 scanning monitor. The letters **P** and **S** refer to the primary (**P**) or secondary (**S**) display values from the transmitting instrument e.g. the primary display value of a conductivity instrument will be the conductivity value on the display whilst the secondary display value would be the solution temperature. The number refers to the address of the instrument. For example if **Ch1Addr** function has **P3** selected then the primary display value from the instrument with address 3 will be requested as the channel 1 input.

- **mbus mode**

With **mbus** selected the display will accept a modbus RTU input. An address (1 to 255) must be selected at the **mbus Add** function to correspond to the address selected at the host device. The instrument accepts modbus command 6 “preset single register” and command 16 “preset multiple registers”. The command 6 or 16 information sent can be used to preset four registers, these are:

Register 0 Decimal point position

Register 1 Input taken as an unsigned 16 bit number (0 to 65535)

Register 2 Input taken as a signed 16 bit number (-32767 to 32767)

Register 3 Signed 32 bit number high order 16 bits

Register 4 Signed 32 bit number low order 16 bits

Registers 3 and 4 are used together to form a 32 bit number. The display will be updated when the low order register is set.

- **NMEA mode**

With **NMEA** selected the instrument must be connected to model WS-MMW-005 solid state wind speed and direction sensor or similar NMEA output sensor. See “Wind Speed and Direction NMEA mode” chapter for wiring details and communications setup requirements.

- **CS mode**

In **CS** mode up to 8 values can be sent in comma separated form. The number of values to

be displayed is set at the **SCAN CH** function. The **▲** or **▼** buttons can be used to view these values or the display can be set to scan between values automatically via the **SCAN SECS** function. An indicator will be displayed just prior to the values e.g. **CH2** to indicate which value will appear next. The format required for this mode is:

<value1>,<value2>.....<value8><CR>

Where: <CR> is the carriage return character.

The **CS** mode can be used with the TP488 scanning monitor and other multi output monitors when the other units **OPut** function is set to **Cont.**

4.31 Alarm relay 1 operation mode

Display: **R1 OPEF**
Range: **INPt, t.out** or **both**
Default Value: **INPt**

Relay 1 operation mode - relay 1 can be made to operate from the input value (e.g. at the **RILo** or **RIH** value, applicable when **Code** is set to **URL** or **̄.buS** only) or when the display blanks due to the timeout value being exceeded (timeout value set at the **dS.to** function). If set to **both** the relay will operate from the display value or if communications fails.

4.32 Alarm relay 2 operation mode

Display: **R2 OPEF**
Range: **INPt, t.out** or **both**
Default Value: **INPt**

Relay 2 operation mode - relay 2 can be made to operate from the input value (e.g. at the **RILo** or **RIH** value, applicable when **Code** is set to **URL** or **̄.buS** only) or when the display blanks due to the timeout value being exceeded (timeout value set at the **dS.to** function). If set to **both** the relay will operate from the display value or if communications fails. Note that this function is only available for the first 2 relays fitted.

4.33 Display timeout

Display: **dS.to**
Range: **0** to **9999**
Default Value: **10**

This function allows the user to set a timeout value for a valid display. Valid times are **0** to **9999** seconds, a setting of **0** disables the timeout. If a new data stream is not received before the timeout value is reached then the display will be blanked.

4.34 Data string timeout

Display: **t.out**
Range: **0.0** to **10.0**
Default Value: **1.0**

This function allows the user to set a timeout value for the data stream. Valid times are **0.0** to **10.0** seconds, a setting of **0.0** disables the timeout. The timeout will cause the current data stream to be ignored if the time gap between characters in the stream exceeds the t.out value. This function helps to prevent false displays when the data stream is interrupted.

4.35 Fast RS485

Display: **FAST RS485**
Range: **on** or **OFF**
Default Value: **OFF**

This function should be set to **on** only when communicating via RS485 with old style RM4 units i.e. RM4 units with 4 digit displays and 6805 processors. This function is used to address timing problems when communicating with these version instruments.

4.36 Digital output option mode

Display: **d90P**
Range: **bcd**, **b.SCL**, **b, n** or **b, n2**
Default Value: **b, n2**

Seen only with the 16 bit digital output option. Refer to the separate “PM4 Panel Meter Optional Output Addendum” booklet supplied when this option is fitted. Selections available are: **b, n2** (signed binary) i.e. -32767 to 32767, **b, n** (unsigned binary) i.e. 0 to 65535, **b.SCL** (scaled binary, see **d, 9-** and **d, 9~** below), **bcd** (binary coded decimal) i.e. up to four BCD numbers.

4.37 Digital output option polarity

Display: **d9.OP**
Range: **Al 0** or **AH,**
Default Value: **Al 0**

Seen only with the 16 bit digital output option. Refer to the separate “PM4 Panel Meter Optional Output Addendum” booklet supplied when this option is fitted. Selections available are: **Al 0** (active low i.e. logic 1 = 0V output, logic 0 = +V output) or **AH,** (active high i.e. logic 1 = +V output, logic 0 = 0V output).

4.38 Digital output option BCD start position

Display: **bcd Start**
Range: **0, 1 or 2**
Default Value: **0**

Seen only with the 16 bit digital output option. Refer to the separate “PM4 Panel Meter Optional Output Addendum” booklet supplied when this option is fitted. This function affects BCD mode only and determines the number of digits to skip when outputting from the display. As the output is 16 bit it can output up to 4 BCD numbers. Select from **0** to number of display digits minus 4. e.g. for a 6 digit display you may select **0** to **2**, if **2** is selected then the four left most digits will be output, if set to **0** then the four right most digits will be output.

4.39 Digital output option low value

Display: **d, 9-**
Range: Any display value
Default Value: **0**

Seen only with the 16 bit digital output option. Refer to the separate “PM4 Panel Meter Optional Output Addendum” booklet supplied when this option is fitted. Accepts any valid display value. Determines the low scaling point for the **b.SCL** mode and has no effect on other modes. See example which follows in 4.40.

4.40 Digital output option high value

Display: **d, 9^**
Range: Any display value
Default Value: **1000**

Seen only with the 16 bit digital output option. Refer to the separate “PM4 Panel Meter Optional Output Addendum” booklet supplied when this option is fitted. Determines the high scaling point for the **b.SCL** mode and has no effect on other modes.

Example:

If **d, 9-** is set to **0** and **d, 9^** is set to **65535** ($2^{16} - 1$) then the retransmission will not be scaled i.e. a display of **2** will cause a retransmission of 2. If **d, 9^** is now changed to **32767** ($2^{15} - 1$) then a display of **2** will cause a retransmission of 4 (note: rounding may occur on retransmission).

4.41 Digital output option channel

Display: **dout CHAN**
Range: **ch0 to ch8**
Default Value: **ch0**

Channel for digital output - applicable only in **AFtH**, **SCAN**, **CS** or **AAEA** mode. This function

allows selection of the input channel to be retransmitted on the digital output. If multiple input channels are not being used then leave this function set to **CHO**. For **AREA** mode channel 1 is the wind direction and channel 2 is the wind speed.

4.42 **P** button function

Display: **P.but**
 Range: **NONE.H, .Lo.H, Lo.tARE** or **ZERO**
 Default Value: **NONE**

P button function - The following applies only when the **CODE** function is set to **URL**. The **P** button (5, 6 or 8 digit LED models only) may be set to operate some of the remote input functions. With the tare and zero functions, to prevent accidental operation, the **P** button must be held pressed for 2-3 seconds before the display will tare or zero, momentary operation of the tare function will cause the gross value to be displayed, preceded by the message **GRDS**. If both the remote input and **P** button function are operated simultaneously the **P** button will override the remote input. The functions below are as described in the **FUNCTION** function below. Functions available are: **NONE.H, .Lo.H, Lo.tARE** or **ZERO**

4.43 Remote input function

Display: **FUNCTION**
 Range: **NONE.P.HLD.d.HLD.H, .Lo.H, Lo.tARE.ZERO.SP.Ac.No.Ac**
 or **dULL**
 Default Value: **NONE**

Remote input function - When these remote input terminals are short circuited, via a switch, relay, keyswitch etc. the instrument will perform the selected remote input function. A message will flash to indicate which function has been selected when the remote input pins are short circuited. The remote input functions are as follows:

NONE - no remote function required i.e. activating the remote input has no effect.

P.HLD - peak hold. The display will show the peak value (highest positive value) only whilst the remote input terminals are short circuited i.e. the display value can rise but not fall whilst the input terminals are short circuited. The message **P.HLD** will appear briefly every 8 seconds whilst the input terminals are short circuited to indicate that the peak hold function is active.

d.HLD - display hold. The display value will be held whilst the remote input terminals are short circuited. The message **d.HLD** will appear briefly every 8 seconds whilst the input terminals are short circuited to indicate that the display hold function is active.

H - peak memory. The peak value stored in memory will be displayed if the remote input terminals are short circuited, if the short circuit is momentary then the display will return to normal measurement after 20 seconds. If the short circuit is held for 2 to 3 seconds or the power is removed from the instrument then the memory will be reset.

Lo - valley memory. The minimum value stored in memory will be displayed. Otherwise operates in the same manner as the **H** function described above.

H, Lo - toggle between **H** and **Lo** displays. This function allows the remote input to be used to toggle between peak and valley memory displays. The first operation of the remote input will cause the peak memory value to be displayed, the next operation will give a valley memory display. **PH**, or **PLo** will flash before each display to give an indication of display type.

tARE - display tare. Short circuiting the remote input pins momentarily will allow toggling between nett and gross values (shown as **NETt** and **gROS**). If the remote input is short circuited for approx. 2 seconds the display will be tared and will show zero. The tare will be lost if power is removed.

ZERO - display zero. Zeroes the display in same manner as the tare function except that the zero is not lost when power is removed and the display will zero as soon as the remote input is shorted. When the **ZERO** operation is used the gross value cannot be recalled and the input at the time of the **ZERO** operation will become the new zero point.

SP.Ac - setpoint access only. This blocks access to any functions except the alarm setpoint functions unless the remote input pins are short circuited or entry is made via **CAL** mode or if the **ACCS** function is set to **ALL**.

No.Ac - no access. This blocks access to all functions unless the remote input pins are short circuited or entry is made via **CAL** mode or if the **ACCS** function is set to **ALL**.

dULL - display brightness control. The remote input can be used to change the display brightness. When this mode is selected the display brightness can be switched, via the remote input terminals, between the brightness level set at the **br9t** function and the brightness level set at the **dULL** function.

4.44 Access mode

Display: **ACCS**
Range: **OFF.EASY.NONE** or **ALL**
Default Value: **OFF**

Access mode - the access mode function **ACCS** has four possible settings namely **OFF.EASY.NONE** and **ALL**. If set to **OFF** the mode function has no effect on alarm relay operation. If set to **EASY** the “easy alarm access” mode will be activated. Refer to “Easy alarm relay adjustment access facility” page 17. If set to **NONE** there will be no access to any functions via **FUNC** mode, entry via **CAL** mode must be made to gain access to alarm and calibration functions. If set to **ALL** then access to all functions, including calibration functions, can be gained via **FUNC** mode.

4.45 Setpoint access mode

Display: **SPAc**
Range: **A1.A1-2** etc.
Default Value: **A1**

Setpoint access - seen only if more than 1 relay fitted. Sets the access via **FUNC** mode and “easy

alarm access” mode to the alarm relay setpoints. The following choices are available:

A 1 - Allows setpoint access to alarm 1 only.

A 1-2 - Allows setpoint access to alarms 1 and 2 only.

A 1-3 - Allows setpoint access to alarms 1, 2 and 3 etc. up to the maximum number of relays fitted.

The remote input function (**F.I NP**) must be set to **SP.AC** for this function to operate. Note: Only the setpoints which have been given a value will be accessible e.g. if **A 1H** is set to **OFF** then there will be no access to the **A 1H** function when **SP.AC** is used.

4.46 Alarm relay 1 operation channel

Display: **A 1**
Range: **ch0** to **ch8**
Default Value: **ch0**

Alarm relay 1 allocation - applicable only to **Arth**, **NAEA**, **SCAN** and **CS** modes. Allows relay 1 to be allocated to one channel. Settings available are **ch0**, **ch 1**, **ch2**, **ch3**, **ch4**, **ch5**, **ch6**, **ch7** or **ch8**. In **NAEA** mode **ch 1** represents wind direction and **ch2** represents wind speed. In **Arth** mode **ch0** represents the arithmetic result. **ch0** should not be selected for any other mode.

4.47 Alarm relays 2 to 7 operation channel

Display: **A2** to **A7**
Range: **ch0** to **ch8**
Default Value: **ch0**

Alarm relay allocation for relays 2, 3, 5, 5, 6 and 7 - applicable only to **Arth**, **NAEA**, **SCAN** and **CS** modes. See section 4.46

4.48 Number of active channels for **Arth** mode

Display: **Arth CH**
Range: **1** to **8**
Default Value: **4**

Displays and selects the number of active input channels used in the arithmetic operation. The instrument will automatically poll the number of channels selected.

4.49 Channel 1 address

Display: **Ch1 Addr**
Range: **P1** to **P8** or **S1** to **S8** or **t1** to **t8**
Default Value: **P1**

Seen only when **Code** function is set to **SCAN** or **Arth**. The instruments connected to the display for scanning purposes must be of the same manufacture this instrument. These units allow a primary and in some cases secondary values to be sent. Refer to the separate manuals supplied when this option is fitted to see if secondary values are available for that instrument. The primary value is the main display value for that instrument e.g. For a conductivity instrument the conductivity would be the primary value and the temperature the secondary. Addresses available are **P1** to **P8** (to poll for primary values), **S1** to **S8** (to poll for secondary values) and **t1** to **t8** (to poll a channel of model TP488 scanning monitor). The numerical value refers to the channel number of a TP488 scanning monitor, for other instruments the numerical value is the address which is set at the **Addr** function of the instrument being polled. For example if **Ch2 Addr** is set to **P2** then the value will be returned will be the primary display value from the instrument whose **Addr** function is set to **2**.

4.50 Channel 2 address

Display: **Ch2 Addr**
Range: **P1** to **P8** or **S1** to **S8** or **t1** to **t8**
Default Value: **P1**

Seen only when **Code** function is set to **SCAN** or **Arth**. Scan address for channel 2, see function 4.49 for further information.

4.51 Channel 3 address

Display: **Ch3 Addr**
Range: **P1** to **P8** or **S1** to **S8** or **t1** to **t8**
Default Value: **P1**

Seen only when **Code** function is set to **SCAN** or **Arth**. Scan address for channel 3, see function 4.49 for further information.

4.52 Channel 4 address

Display: **Ch4 Addr**
Range: **P1** to **P8** or **S1** to **S8** or **t1** to **t8**
Default Value: **P1**

Seen only when **Code** function is set to **SCAN** or **Arth**. Scan address for channel 4, see function 4.49 for further information.

4.53 Channel 5 address

Display: **Ch5 Addr**
Range: **P 1 to P8 or S 1 to S8 or t 1 to t8**
Default Value: **P 1**

Seen only when **Code** function is set to **SCAN** or **Arth**. Scan address for channel 5, see function 4.49 for further information.

4.54 Channel 6 address

Display: **Ch6 Addr**
Range: **P 1 to P8 or S 1 to S8 or t 1 to t8**
Default Value: **P 1**

Seen only when **Code** function is set to **SCAN** or **Arth**. Scan address for channel 6, see function 4.49 for further information.

4.55 Channel 7 address

Display: **Ch7 Addr**
Range: **P 1 to P8 or S 1 to S8 or t 1 to t8**
Default Value: **P 1**

Seen only when **Code** function is set to **SCAN** or **Arth**. Scan address for channel 7, see function 4.49 for further information.



4.56 Channel 8 address

Display: **Ch8 Addr**
Range: **P 1 to P8 or S 1 to S8 or t 1 to t8**
Default Value: **P 1**

Seen only when **Code** function is set to **SCAN** or **Arth**. Scan address for channel 8, see function 4.49 for further information.

4.57 Channel 1 decimal point

Display: **Ch1 dCpt**
Range: **0, 0. 1** etc.
Default Value: **0**

Seen only in **Code = Arth** mode. Displays and sets the decimal point for input channel 1. By pressing the  or  pushbuttons the decimal point position may be set. The display will indicate as follows: **0** (no decimal point), **0. 1** (1 decimal place), **0.02** (2 decimal places) etc.

4.58 Channel 2 decimal point

Display: **Ch2 dCPt**

Range: **0, 0.1** etc.

Default Value: **0**

Seen only in **Code = Arth** mode. Displays and sets the decimal point for input channel 2. See function [4.57](#) for further details.

4.59 Channel 3 decimal point

Display: **Ch3 dCPt**

Range: **0, 0.1** etc.

Default Value: **0**

Seen only in **Code = Arth** mode. Displays and sets the decimal point for input channel 3. See function [4.57](#) for further details.

4.60 Channel 4 decimal point

Display: **Ch4 dCPt**

Range: **0, 0.1** etc.

Default Value: **0**

Seen only in **Code = Arth** mode. Displays and sets the decimal point for input channel 2. See function [4.57](#) for further details.

4.61 Channel 5 decimal point

Display: **Ch5 dCPt**

Range: **0, 0.1** etc.

Default Value: **0**

Seen only in **Code = Arth** mode. Displays and sets the decimal point for input channel 5. See function [4.57](#) for further details.

4.62 Channel 6 decimal point

Display: **Ch6 dCPt**

Range: **0, 0.1** etc.

Default Value: **0**

Seen only in **Code = Arth** mode. Displays and sets the decimal point for input channel 6. See function [4.57](#) for further details.

4.63 Channel 7 decimal point

Display: **Ch7 dCPt**

Range: **0, 0.1** etc.

Default Value: **0**

Seen only in **Code = Arth** mode. Displays and sets the decimal point for input channel 7. See function 4.57 for further details.

4.64 Channel 8 decimal point

Display: **Ch8 dCPt**

Range: **0, 0.1** etc.

Default Value: **0**

Seen only in **Code = Arth** mode. Displays and sets the decimal point for input channel 8. See function 4.57 for further details.

4.65 Channel 1 **EA1** value for arithmetic formula

Display: **EA1**

Range: **-32727 to 32767**

Default Value: **1**

Seen only in **Set Oper = Arth** mode. Displays and sets the **EA1** value to be used in the arithmetic formula. If the number of display digits allows a range from **-32727 to 32767** is available for this function. This value is used together with the input value for channel 1, the **Eb1** and **EC1** to produce the a value to be used in the formula below:

$$\frac{EA1 * (Ch1 + Eb1)}{EC1} \left\{ \begin{array}{l} \text{Add} \\ \text{Sub} \\ \text{Prod} \\ \text{d, U} \\ \text{hi gh} \\ \text{Lo} \\ \text{Si, nE} \\ \text{CoS} \\ \text{C.SUB} \end{array} \right\} \frac{EA2 * (Ch2 + Eb2)}{EC2} \left\{ \begin{array}{l} \text{Add} \\ \text{Sub} \\ \text{Prod} \\ \text{d, U} \\ \text{hi gh} \\ \text{Lo} \\ \text{Si, nE} \\ \text{CoS} \\ \text{C.SUB} \end{array} \right\} \frac{EA3 * (Ch3 + Eb3)}{EC3}$$

Note: **A** and **C** are whole numbers, **b** has the same decimal place setting as its associated channel.

4.66 Channel 1 **EB1** value for arithmetic formula

Display: **EB1**
Range: **-32727 to 32767**
Default Value: **0**

Seen only in **SEt OPER = Arth** mode. Displays and sets the **EB1** value to be used in the arithmetic formula. See function [4.65](#) for further details.

4.67 Channel 2 **EC2** value for arithmetic formula

Display: **EC2**
Range: **-32727 to 32767**
Default Value: **1**

Seen only in **SEt OPER = Arth** mode. Displays and sets the **EC2** value to be used in the arithmetic formula. See function [4.65](#) for further details.

4.68 Channel 2 **EA2** value for arithmetic formula

Display: **EA2**
Range: **-32727 to 32767**
Default Value: **1**

Seen only in **SEt OPER = Arth** mode. Displays and sets the **EA2** value to be used in the arithmetic formula. See function [4.65](#) for further details.

4.69 Channel 2 **EB2** value for arithmetic formula

Display: **EB2**
Range: **-32727 to 32767**
Default Value: **0**

Seen only in **SEt OPER = Arth** mode. Displays and sets the **EB2** value to be used in the arithmetic formula. See function [4.65](#) for further details.

4.70 Channel 2 **EC2** value for arithmetic formula

Display: **EC2**
Range: **-32727 to 32767**
Default Value: **1**

Seen only in **SEt OPER = Arth** mode. Displays and sets the **EC2** value to be used in the arithmetic formula. See function [4.65](#) for further details.

4.71 Channel 3 **EA3** value for arithmetic formula

Display: **EA3**
Range: **-32727 to 32767**
Default Value: **1**

Seen only in **SEt OPER = Arth** mode. Displays and sets the **EA3** value to be used in the arithmetic formula. See function [4.65](#) for further details.

4.72 Channel 3 **Eb3** value for arithmetic formula

Display: **Eb3**
Range: **-32727 to 32767**
Default Value: **0**

Seen only in **SEt OPER = Arth** mode. Displays and sets the **Eb3** value to be used in the arithmetic formula. See function [4.65](#) for further details.

4.73 Channel 3 **EC3** value for arithmetic formula

Display: **EC3**
Range: **-32727 to 32767**
Default Value: **1**

Seen only in **SEt OPER = Arth** mode. Displays and sets the **EC3** value to be used in the arithmetic formula. See function [4.65](#) for further details.

4.74 Channel 4 **EA4** value for arithmetic formula

Display: **EA4**
Range: **-32727 to 32767**
Default Value: **1**

Seen only in **Code = Arth** mode. Displays and sets the **EA4** value to be used in the arithmetic formula. See function [4.65](#) for further details.

4.75 Channel 4 **Eb4** value for arithmetic formula

Display: **Eb4**
Range: **-32727 to 32767**
Default Value: **0**

Seen only in **Code = Arth** mode. Displays and sets the **Eb4** value to be used in the arithmetic formula. See function [4.65](#) for further details.

4.76 Channel 4 **EC4** value for arithmetic formula

Display: **EC4**
Range: **-32727 to 32767**
Default Value: **1**

Seen only in **Code = Arth** mode. Displays and sets the **EC4** value to be used in the arithmetic formula. See function 4.65 for further details.

4.77 Channel 5 **EAS** value for arithmetic formula

Display: **EAS**
Range: **-32727 to 32767**
Default Value: **1**

Seen only in **Code = Arth** mode. Displays and sets the **EAS** value to be used in the arithmetic formula. See function 4.65 for further details.

4.78 Channel 5 **Eb5** value for arithmetic formula

Display: **Eb5**
Range: **-32727 to 32767**
Default Value: **0**

Seen only in **Code = Arth** mode. Displays and sets the **Eb5** value to be used in the arithmetic formula. See function 4.65 for further details.

4.79 Channel 5 **ECS** value for arithmetic formula

Display: **ECS**
Range: **-32727 to 32767**
Default Value: **1**

Seen only in **Code = Arth** mode. Displays and sets the **ECS** value to be used in the arithmetic formula. See function 4.65 for further details.

4.80 Channel 6 **EAB** value for arithmetic formula

Display: **EAB**
Range: **-32727 to 32767**
Default Value: **1**

Seen only in **Code = Arth** mode. Displays and sets the **EAB** value to be used in the arithmetic formula. See function 4.65 for further details.

4.81 Channel 6 **EB6** value for arithmetic formula

Display: **EB6**
Range: **-32727** to **32767**
Default Value: **0**

Seen only in **Code = Arth** mode. Displays and sets the **EB6** value to be used in the arithmetic formula. See function 4.65 for further details.

4.82 Channel 6 **EC6** value for arithmetic formula

Display: **EC6**
Range: **-32727** to **32767**
Default Value: **!**

Seen only in **Code = Arth** mode. Displays and sets the **EC6** value to be used in the arithmetic formula. See function 4.65 for further details.

4.83 Channel 7 **EA7** value for arithmetic formula

Display: **EA7**
Range: **-32727** to **32767**
Default Value: **!**

Seen only in **Code = Arth** mode. Displays and sets the **EA7** value to be used in the arithmetic formula. See function 4.65 for further details.

4.84 Channel 7 **EB7** value for arithmetic formula

Display: **EB7**
Range: **-32727** to **32767**
Default Value: **0**

Seen only in **Code = Arth** mode. Displays and sets the **EB7** value to be used in the arithmetic formula. See function 4.65 for further details.

4.85 Channel 7 **EC7** value for arithmetic formula

Display: **EC7**
Range: **-32727** to **32767**
Default Value: **!**

Seen only in **Code = Arth** mode. Displays and sets the **EC7** value to be used in the arithmetic formula. See function 4.65 for further details.

4.86 Channel 8 **EAB** value for arithmetic formula

Display: **EAB**
Range: **-32727** to **32767**
Default Value: **!**

Seen only in **Code = Arth** mode. Displays and sets the **EAB** value to be used in the arithmetic formula. See function 4.65 for further details.

4.87 Channel 8 **EbB** value for arithmetic formula

Display: **EbB**
Range: **-32727** to **32767**
Default Value: **0**

Seen only in **Code = Arth** mode. Displays and sets the **EbB** value to be used in the arithmetic formula. See function 4.65 for further details.

4.88 Channel 8 **ECB** value for arithmetic formula

Display: **ECB**
Range: **-32727** to **32767**
Default Value: **!**

Seen only in **Code = Arth** mode. Displays and sets the **ECB** value to be used in the arithmetic formula. See function 4.65 for further details.

4.89 Channel 1 polarity

Display: **Ch 1**
Range: **both, POS** or **NEG**
Default Value: **both**

Displays and sets the polarity selection for the display of the engineering value for channel 1. If set to **BOTH** then the display will be able to indicate both positive and negative values. If set to **POS** the display will allow only positive values with any values below zero being rounded to zero. If set to **NEG** then the display will allow only negative values with any value above zero being rounded to zero.

4.90 Channel 2 polarity

Display: **Ch2**
Range: **both, POS** or **NEG**
Default Value: **both**

Displays and sets the polarity selection for the display of the engineering value for channel 2. See function [4.89](#) for further information.

4.91 Channel 3 polarity

Display: **Ch3**
Range: **both, POS** or **NEG**
Default Value: **both**

Displays and sets the polarity selection for the display of the engineering value for channel 3. See function [4.89](#) for further information.

4.92 Channel 4 polarity

Display: **Ch4**
Range: **both, POS** or **NEG**
Default Value: **both**

Displays and sets the polarity selection for the display of the engineering value for channel 4. See function [4.89](#) for further information.

4.93 Channel 5 polarity

Display: **Ch5**
Range: **both, POS** or **NEG**
Default Value: **both**

Displays and sets the polarity selection for the display of the engineering value for channel 5. See function [4.89](#) for further information.

4.94 Channel 6 polarity

Display: **Ch6**
Range: **both, POS** or **NEG**
Default Value: **both**

Displays and sets the polarity selection for the display of the engineering value for channel 6. See function [4.89](#) for further information.

4.95 Channel 7 polarity

Display: **Ch7**
Range: **both, POS** or **NEG**
Default Value: **both**

Displays and sets the polarity selection for the display of the engineering value for channel 7. See function 4.89 for further information.

4.96 Channel 8 polarity

Display: **Ch8**
Range: **both, POS** or **NEG**
Default Value: **both**

Displays and sets the polarity selection for the display of the engineering value for channel 8. See function 4.89 for further information.

4.97 Arithmetic operation between channels 1 and 2

Display: **OP 1**
Range: **Add, Sub, Prod, d, U, Hi, Gh, Lo, Si, NE, COS** or **C.Sub**
Default Value: **Add**

Displays the arithmetic operation to be undertaken between the formula for channels 1 and 2. See also function 4.65 which illustrates the formula.

Choices are:

- **Add** - channel 1 formula plus channel 2 formula
- **Sub** - channel 1 formula minus channel 2 formula
- **Prod** - channel 1 formula times channel 2 formula
- **d, U** - channel 1 formula divided by channel 2 formula
- **Hi, Gh** - highest of channel 1 formula or channel 2 formula
- **Lo** - lowest of channel 1 formula or channel 2 formula
- **Si, NE** - channel 1 formula times the sine of the angle represented by channel 2 formula
- **COS** - channel 1 formula times the cosine of the angle represented by channel 2 formula
- **C.Sub** - channel 1 formula clock time input minus channel 2 formula clock time.

Note: **C.Sub** is meant to be used when connecting to two clocks with compatible serial outputs.

4.98 Arithmetic operation between channel 3 and previous operation

Display: **OP2**
Range: **Add, Sub, Prod, d, U, H, Gh, Lo, SINE** or **COS**
Default Value: **Add**

Displays the arithmetic operation to be undertaken between the channel 3 formula and the previous result. See also function 4.65 which illustrates the formula.

Choices are:

- **Add** - mathematical result of **OP 1** plus channel 3 formula
- **Sub** - mathematical result of **OP 1** minus channel 3 formula
- **Prod** - mathematical result of **OP 1** times channel 3 formula
- **d, U** - mathematical result of **OP 1** divided by channel 3 formula
- **H, Gh** - highest of mathematical result of **OP 1** or channel 3 formula
- **Lo** - lowest of mathematical result of **OP 1** or channel 3 formula
- **SINE** - mathematical result of **OP 1** times the sine of the angle represented by channel 3 formula
- **COS** - mathematical result of **OP 1** times the cosine of the angle represented by channel 3 formula

4.99 Arithmetic operation between channel 4 and previous operation

Display: **OP3**
Range: **Add, Sub, Prod, d, U, H, Gh, Lo, SINE** or **COS**
Default Value: **Add**

Displays the arithmetic operation to be undertaken between the channel 4 formula and the previous result. See also function 4.65 which illustrates the formula.

Choices are:

- **Add** - mathematical result of **OP 1** and **OP2** plus channel 4 formula
- **Sub** - mathematical result of **OP 1** and **OP2** minus channel 4 formula
- **Prod** - mathematical result of **OP 1** and **OP2** times channel 4 formula
- **d, U** - mathematical result of **OP 1** and **OP2** divided by channel 4 formula
- **H, Gh** - highest of mathematical result of **OP 1** and **OP2** or channel 4 formula
- **Lo** - lowest of mathematical result of **OP 1** and **OP2** or channel 4 formula
- **SINE** - mathematical result of **OP 1** and **OP2** times the sine of the angle represented by channel 4 formula

- **COS** - mathematical result of **OP 1** and **OP2** times the cosine of the angle represented by channel 4 formula

4.100 Arithmetic operation between channel 5 and previous operation

Display: **OP4**

Range: **Add, Sub, Prod, d, U, H, Gh, Lo, SINE** or **COS**

Default Value: **Add**

Displays the arithmetic operation to be undertaken between the channel 5 formula and the previous result. See also function 4.65 which illustrates the formula.

Choices are:

- **Add** - mathematical result of **OP 1** and **OP2** and **OP3** plus channel 5 formula
- **Sub** - mathematical result of **OP 1** and **OP2** and **OP3** minus channel 5 formula
- **Prod** - mathematical result of **OP 1** and **OP2** and **OP3** times channel 5 formula
- **d, U** - mathematical result of **OP 1** and **OP2** and **OP3** divided by channel 5 formula
- **H, Gh** - highest of mathematical result of **OP 1** and **OP2** and **OP3** or channel 5 formula
- **Lo** - lowest of mathematical result of **OP 1** and **OP2** and **OP3** or channel 5 formula
- **SINE** - mathematical result of **OP 1** and **OP2** and **OP3** times the sine of the angle represented by channel 5 formula
- **COS** - mathematical result of **OP 1** and **OP2** and **OP3** times the cosine of the angle represented by channel 5 formula

4.101 Arithmetic operation between channel 6 and previous operation

Display: **OP5**

Range: **Add, Sub, Prod, d, U, H, Gh, Lo, SINE** or **COS**

Default Value: **Add**

Displays the arithmetic operation to be undertaken between the channel 6 formula and the previous result. See also function 4.65 which illustrates the formula.

Choices are:

- **Add** - mathematical result of **OP 1** and **OP2** and **OP3** and **OP4** plus channel 6 formula
- **Sub** - mathematical result of **OP 1** and **OP2** and **OP3** and **OP4** minus channel 6 formula
- **Prod** - mathematical result of **OP 1** and **OP2** and **OP3** and **OP4** times channel 6 formula
- **d, U** - mathematical result of **OP 1** and **OP2** and **OP3** and **OP4** divided by channel 6 formula
- **H, Gh** - highest of mathematical result of **OP 1** and **OP2** and **OP3** and **OP4** or channel 6 formula

- **Lo** - lowest of mathematical result of **OP 1** and **OP2** and **OP3** and **OP4** or channel 6 formula
- **S, nE** - mathematical result of **OP 1** and **OP2** and **OP3** and **OP4** times the sine of the angle represented by channel 6 formula
- **COS** - mathematical result of **OP 1** and **OP2** and **OP3** and **OP4** times the cosine of the angle represented by channel 6 formula

4.102 Arithmetic operation between channel 7 and previous operation

Display: **OP6**
 Range: **Add, Sub, Prod, d, U, H, Gh, Lo, S, nE** or **COS**
 Default Value: **Add**

Displays the arithmetic operation to be undertaken between the channel 7 formula and the previous result. See also function 4.65 which illustrates the formula.

Choices are:

- **Add** - mathematical result of **OP 1** and **OP2** and **OP3** and **OP4** and **OPS** plus channel 7 formula
- **Sub** - mathematical result of **OP 1** and **OP2** and **OP3** and **OP4** and **OPS** minus channel 7 formula
- **Prod** - mathematical result of **OP 1** and **OP2** and **OP3** and **OP4** and **OPS** times channel 7 formula
- **d, U** - mathematical result of **OP 1** and **OP2** and **OP3** and **OP4** and **OPS** divided by channel 7 formula
- **H, Gh** - highest of mathematical result of **OP 1** and **OP2** and **OP3** and **OP4** and **OPS** or channel 7 formula
- **Lo** - lowest of mathematical result of **OP 1** and **OP2** and **OP3** and **OP4** and **OPS** or channel 7 formula
- **S, nE** - mathematical result of **OP 1** and **OP2** and **OP3** and **OP4** and **OPS** times the sine of the angle represented by channel 7 formula
- **COS** - mathematical result of **OP 1** and **OP2** and **OP3** and **OP4** and **OPS** times the cosine of the angle represented by channel 7 formula

4.103 Arithmetic operation between channel 8 and previous operation

Display: **OP7**
 Range: **Add, Sub, Prod, d, U, H, Gh, Lo, S, nE** or **COS**
 Default Value: **Add**

Displays the arithmetic operation to be undertaken between the channel 8 formula and the previous result. See also function 4.65 which illustrates the formula.

Choices are:

- **Add** - mathematical result of **OP 1** and **OP2** and **OP3** and **OP4** and **OP5** and **OP6** plus channel 8 formula
- **Sub** - mathematical result of **OP 1** and **OP2** and **OP3** and **OP4** and **OP5** and **OP6** minus channel 8 formula
- **Prod** - mathematical result of **OP 1** and **OP2** and **OP3** and **OP4** and **OP5** and **OP6** times channel 8 formula
- **Div** - mathematical result of **OP 1** and **OP2** and **OP3** and **OP4** and **OP5** and **OP6** divided by channel 8 formula
- **Hi, Gh** - highest of mathematical result of **OP 1** and **OP2** and **OP3** and **OP4** and **OP5** and **OP6** or channel 8 formula
- **Lo** - lowest of mathematical result of **OP 1** and **OP2** and **OP3** and **OP4** and **OP5** and **OP6** or channel 8 formula
- **Sine** - mathematical result of **OP 1** and **OP2** and **OP3** and **OP4** and **OP5** and **OP6** times the sine of the angle represented by channel 8 formula
- **COS** - mathematical result of **OP 1** and **OP2** and **OP3** and **OP4** and **OP5** and **OP6** times the cosine of the angle represented by channel 8 formula

4.104 Clear zero

Display: **CLR ZERO**

Range: n/a

Default Value: n/a

Seen only when **Code** function = **URL** or **RFEM**. Allows any zero operations performed via the remote input or **P** button to be cleared. Pressing the **▲** and **▼** buttons simultaneously will clear the zero offset, the message **CLrd** will be seen, confirming the zero clearing operation is completed. The instrument will then return to displaying the value of the string sent.

4.105 Baud rate for serial retransmission

Display: **Serial BAUD**

Range: **300, 600, 1200, 2400, 4800, 9600, 19.2** or **38.4**

Default Value: **9600**

Seen only when serial retransmission is fitted. Refer to the separate “Optional Output Addendum” booklet supplied when this option is fitted. The baud rate should be chosen to match that of the device to which this instrument is connected.

4.106 Parity for serial retransmission

Display: ***Serial Prty***
Range: ***NONE, EVEN*** or ***Odd***
Default Value: ***NONE***

Seen only when serial retransmission is fitted. Refer to the separate “Optional Output Addendum” booklet supplied when this option is fitted. The parity should be chosen to match that of the device to which this instrument is connected.

4.107 Output mode for serial retransmission

Display: ***Serial O.Put***
Range: ***NONE, dl SP, Cont, POLL, Cont, A.bus*** or ***R.bus***
Default Value: ***NONE***

Seen only when serial retransmission is fitted. Refer to the separate “Optional Output Addendum” booklet supplied when this option is fitted. Selects the required output mode for retransmission. Note: if the ***Code*** function is set to ***ASCII*** then only the ***dl SP*** output selection can be used.

4.108 Address for serial retransmission

Display: ***Serial Addr***
Range: ***0*** to ***31***
Default Value: ***0***

Seen only when serial retransmission is fitted. Refer to the separate “Optional Output Addendum” booklet supplied when this option is fitted. Selects the required address for retransmission when in ***POLL*** output mode using RS485 retransmission. Addressing allows several units to operate on the same RS485 interface. The host computer or PLC may poll each unit in turn, supplying the appropriate address. The unit addresses range from 0 to 31 (DEC) but is offset by 32 (DEC) to avoid clashing with special function characters such as <STX> and <CR>. For example 32 (DEC) (space in ASCII) is address 0 and 42 (DEC) (* in ASCII) is address 10.

5 Arithmetic function examples

Example 1: To get an average of channels 1, 2, 3 and 4 each input is added together and divided by 4:

Program:

```
EA1 = 1, Eb1 = 0, EC1 = 4,
EA2 = 1, Eb2 = 0, EC2 = 4,
EA3 = 1, Eb3 = 0, EC3 = 4,
EA4 = 1, Eb4 = 0, EC4 = 4,
OP1 = Add,
OP2 = Add,
OP3 = Add
```

$$\frac{1 * (Ch1 + 0)}{4} \text{ Add } \frac{1 * (Ch2 + 0)}{4} \text{ Add } \frac{1 * (Ch3 + 0)}{4} \text{ Add } \frac{1 * (Ch4 + 0)}{4}$$

Example 2: Three inputs are present. The display is to indicate the highest of the 3 inputs. Channel 1 input is to be multiplied 2/3.

Program:

```
EA1 = 2, Eb1 = 0, EC1 = 3,
EA2 = 1, Eb2 = 0, EC2 = 1,
EA3 = 1, Eb3 = 0, EC3 = 1,
OP1 = H, 9H,
OP2 = H, 9H
```

$$\frac{2 * (Ch1 + 0)}{3} \text{ HIGH } \frac{1 * (Ch2 + 0)}{1} \text{ HIGH } \frac{1 * (Ch3 + 0)}{1}$$

Example 3: To multiply the figure displayed on channel 1 by the sine of the angle of the figure displayed on channel 2. The second channel would normally be scaled from 0 to 360 when either the sine or cosine is being used, however numbers outside this range are acceptable.

Program:

```
EA1 = 1, Eb1 = 0, EC1 = 1,
EA2 = 1, Eb2 = 0, EC2 = 1,
OP1 = SINE
```

$$\frac{1 * (Ch1 + 0)}{1} \text{ SINE } \frac{1 * (Ch2 + 0)}{1}$$

6 Function table - Wind Speed and Direction mode

Note: the order in which the functions appear on the display may not be exactly as shown below. The availability and order of functions is determined by choice of function settings and options fitted.

Functions in this first table are available in **FUNC** or **CAL** mode

Display	Function	Range	Default	Your record	Ref/Page
AxLo	Low setpoint value for designated alarm relay <i>x</i>	Any display value or OFF	OFF	See 6.1	4.1 / 18
AxH	High setpoint value for designated alarm relay <i>x</i>	Any display value or OFF	OFF	See 6.1	4.2 / 18
AxHY	Hysteresis value for the designated alarm relay <i>x</i> .	0 to 9999	10	See 6.1	4.3 / 19
Axtt	Trip time delay for the designated alarm relay <i>x</i> .	0 to 9999	0	See 6.1	4.4 / 20
Axrt	Reset time delay for the designated alarm relay <i>x</i> .	0 to 9999	0	See 6.1	4.5 / 20
Axn.o or Axn.c	Alarm relay <i>x</i> action to normally open (de-energised) or normally closed (energised)	Axn.o or Axn.c	Axn.o	See 6.1	4.6 / 20
AxSP or Axt i etc.	Relay operation independent setpoint or trailing setpoint (*Optional)	AxSP or Axt i etc.	AxSP	See 6.1	4.7 / 21
brgt	Display brightness level	1 to 15	15		4.8 / 21
dull	Display remote brightness switching	0 to 15	1		4.9 / 21

(*Optional)—this function will only be accessible if the relevant option is fitted

Functions in this second table are available only in **CAL** mode or if **ACCS** is set to **ALL**

Display	Function	Range	Default	Your record	Ref/Page
bar-	Bargraph low value	Any display value	0		4.10 / 22
bar⁺	Bargraph high value	Any display value	1000		4.11 / 22
bar type	Bargraph type for instruments with bargraph display	bar , S.dot , d.dot , C.bAR or r.dot	bar		4.12 / 22

(*Optional)—this function will only be accessible if the relevant option is fitted

bAR-CHAN	Bargraph channel	0 to 8	0		4.13 / 23
FEC-	Analog output option low display value (* Optional)	Any display value	0		4.14 / 24
FEC+	Analog output option high display value (* Optional)	Any display value	1000		4.15 / 24
rEC	Analog output 1 channel (* Optional)	ch0 to ch8	ch0		4.16 / 24
FEC-CH2	Second analog output option low display value (* Optional)	Any display value	0		4.17 / 25
FEC+CH2	Second analog output option high display value (* Optional)	Any display value	1000		4.18 / 25
rEC2	Analog output 2 channel (* Optional)	ch0 to ch8	ch0		4.19 / 25
SPEd Unit	Units to be used for N&AER mode	AS, APH, hPH or hnot	AS		4.23 / 26
dFLt di SP	Default display for N&AER mode	di r, SPEd or SCAN	SCAN		4.24 / 26
SCAN SECS	Number of seconds between scans	0 to 255	0		4.25 / 27
BAUD RATE	Baud rate for serial communications	300.600.1200.2400.4800.9600.19.2 or 38.4	9600		4.26 / 27
Prty	Parity for serial input	NONE.EVEN or Odd	NONE		4.27 / 27
dAtA	Data type	8.b, t or 7.b, t	8.b, t		4.28 / 27
i nPt	Input type	r232, r422, r485 or i 20	r232		4.29 / 28
Code	Data type for display	di SP, ASCI, UAL, ATeH, A.buS, PteA, SCAN, N&AER or CS	di SP		4.30 / 28
A1 OPER	Alarm relay 1 operation mode	i nPt, t.out or both	i nPt		4.31 / 30
A2 OPER	Alarm relay 2 operation mode	i nPt, t.out or both	i nPt		4.32 / 30
dS.to	Display timeout	0 to 9999	10		4.33 / 30
t.out	Data string timeout	0.0 to 10.0	1.0		4.34 / 31

(***Optional**)—this function will only be accessible if the relevant option is fitted

FAST RS485	Fast RS485	on or OFF	OFF		4.35 / 31
d9OP	Digital output option mode (*Optional)	bcd, b.SCL, b, n or b, n2	b, n2		4.36 / 31
d9.OP	Digital output option polarity (*Optional)	AI 0 or AK,	AI 0		4.37 / 31
bcd Start	Digital output option BCD start position (*Optional)	0, 1 or 2	0		4.38 / 32
d, 9-	Digital output option low value (*Optional)	Any display value	0		4.39 / 32
d, 9+	Digital output option high value (*Optional)	Any display value	1000		4.40 / 32
dout CHAN	Digital output option channel (*Optional)	ch0 to ch8	ch0		4.41 / 32
P.but	P button function	NONE, Hi, Lo, Hi Lo, LRGE or ZERO	NONE		4.42 / 33
FINP	Remote input (external input) one function	NONE, P.HLd, d.HLd, Hi, Lo, Hi, Lo, LRGE, ZERO, SP.Ac, No.Ac or dULL	NONE		4.43 / 33
ACCESS	Access mode	OFF, EASY, NONE or ALL	OFF		4.44 / 34
SPAC	Setpoint access mode (*Optional)	A1, A1-2 etc.	A1		4.45 / 34
A1	Alarm relay 1 operation channel	ch0 to ch8	ch0		4.46 / 35
A2 to A7	Alarm relays 2 to 7 operation channel (*Optional)	ch0 to ch8	ch0		4.47 / 35
Serial baud	Baud rate for serial retransmission (*Optional)	300, 600, 1200, 2400, 4800, 9600, 19.2 or 38.4	9600		4.105 / 50
Serial Parity	Parity for serial retransmission (*Optional)	NONE, EVEN or Odd	NONE		4.106 / 51
Serial Output Mode	Output mode for serial retransmission (*Optional)	NONE, d, SP, Cont, POLL, Cont, n.bus or A.bus	NONE		4.107 / 51

(*Optional)—this function will only be accessible if the relevant option is fitted

Retrn Addr	Address for serial retransmission (*Optional)	0 to 31	0		4.108 / 51
-----------------------	--	----------------	----------	--	------------

(*Optional)—this function will only be accessible if the relevant option is fitted

6.1 Relay table



Record your relay settings in the table below

Display	Relay 1	Relay 2	Relay 3	Relay 4	Relay 5	Relay 6	Relay 7
RxLo							
RxH.							
RxHY							
Rxtt							
Rxrt							
Rxn.o or Rxn.c							
RxSP or Rxt i etc.	n/a						
R1							
R2							
R3							
R4							
R5							
R6							
R7							

7 Wind speed and direction NMEA mode

This chapter deals specifically with the NMEA (National Marine Electronics Association) mode of operation. When used in this mode the display must be connected to a wind sensor with NMEA output such as model WS-MMW-005 solid state wind speed and direction sensor and the displays **Code** function must be set to **NMEA**.

Communication settings require the baud rate (**BAUD RATE** function) to be set to **4800** with no parity (**PRTY** function) and 8 data bits (**DATA** function).

The display can be set to show wind speed, wind direction or to toggle (using  or  button) or automatically alternate the display between wind speed and direction. Analog retransmission output options can be selected to transmit wind direction (**Ch 1**) or wind speed (**Ch2**) at the **FEC** function. Similarly **Ch 1** or **Ch2** can be selected for the alarm relays at the **A 1, A2** etc. functions and for the bargraph using function **BAR CHAN** in bargraph display versions.

Other settings allow the wind speed units and default display to be selected. See Chapter 6, page 53 for details of setup functions for the NMEA wind speed and direction mode.

See section 2.8, page 7 for wiring details of the WS-MMW-005 NMEA wind sensor.