

**Model PM4-IV2**  
**Panel Mount Dual Bar Graph Display**  
**Operation and Instruction Manual**

---

*AMALGAMATED INSTRUMENT CO*

*Unit 5, 28 Leighton Place Hornsby  
NSW 2077 Australia*

*Telephone: +61 2 9476 2244  
Facsimile: +61 2 9476 2902*

*ABN: 80 619 963 692*

*e-mail: [sales@aicpl.com.au](mailto:sales@aicpl.com.au)  
Internet: [www.aicpl.com.au](http://www.aicpl.com.au)*

# Table of Contents

<b>1</b>	<b>Introduction</b>	<b>3</b>
<b>2</b>	<b>Mechanical Installation</b>	<b>5</b>
<b>3</b>	<b>Electrical installation</b>	<b>6</b>
<b>4</b>	<b>Bargraph scaling</b>	<b>12</b>
<b>5</b>	<b>Warning display</b>	<b>13</b>
<b>6</b>	<b>Alarm relay and brightness level settings</b>	<b>15</b>
<b>7</b>	<b>Specifications</b>	<b>17</b>
<b>8</b>	<b>Guarantee and service</b>	<b>18</b>

# 1 Introduction

## 1.1 General description

This manual contains information for the installation and operation of the PM4-IV2 panel mount monitor. The PM4-IV2 is a dual bargraph with dual isolated input panel meter display. This instrument may be configured to accept an input signal of 4 to 20mA, 0 to 2VDC or 0 to 20VDC. Full electrical isolation between each input and power supply is provided by the PM4.

Unless otherwise specified at the time of order, your PM4 has been factory set to a standard configuration. The PM4 series instruments can be configuration and scaled easily by the user. Changes to input type requires dismantling the instrument to alter PCB links.

Scaling of each bargraph display is accomplished by applying live inputs and using the rear push-buttons. The bargraph can be changed from solid bar type display to single segment display using DIP switch 1 at the rear of the instrument.

Relay outputs are optionally available for this instrument. A single relay option or 3 relay option or 6 relay option board may be fitted. The relay option allows either a high or low setpoint to be chosen for each relay. Each relay can be assigned to operate either from Channel 1 or from Channel 2.

The front panel **P** is not assigned any use in this software version.

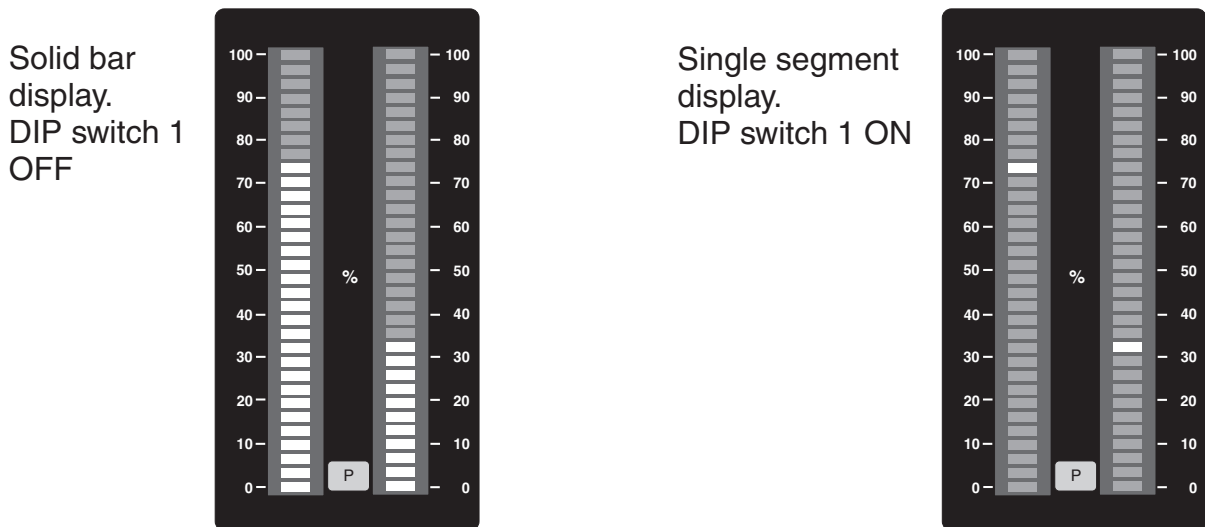

## 1.2 Accessing setup for scaling, relays and display brightness

Use the method below to access the display scaling, relay high and low setpoints and brightness level setup. Note that DIP switch 4 must be in the ON position to access the scaling functions and in the OFF position to access the alarm relay and brightness functions.



1. Remove power from the instrument. Hold in the **F** button and reapply power. All LED's should illuminate then gradually switch off then show the LED level corresponding to the input on each channel. When the display has reached this point the **F** button can be released.

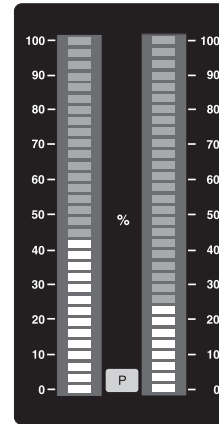

Note: If step 1 above has been completed then the instrument will remain in this scaling mode state until power is removed. i.e. there is no need to repeat step 1 when scaling unless power has been removed.



2. Press the **F** button again then release it.

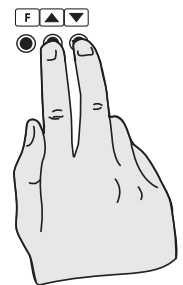

3. Within 2 seconds of releasing the **F** button press then release the **▲** and **▼** buttons together.

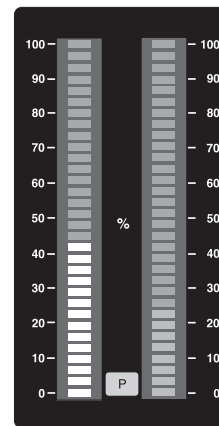

If DIP switch 4 is set to ON then Channel 2 bargraph should blank refer to chapter 4 for further details.

If DIP switch 4 is set to OFF then one bargraph or both bargraphs should flash indicating a relay number see chapter 6 for further details.

## 2 Mechanical Installation

Choose a mounting position as far away as possible from sources of electrical noise such as motors, generators, fluorescent lights, high voltage cables/bus bars etc. An IP65 access cover which may be installed on the panel and surrounds is available as an option to be used when mounting the instrument in damp/dusty positions. A wall mount case is available, as an option, for situations in which panel mounting is either not available or not appropriate. A portable carry case is also available, as an option, for panel mount instruments.

Prepare a panel cut out of 45mm x 92mm +1 mm / - 0 mm (see diagram below). Insert the instrument into the cut out from the front of the panel. From the rear of the instrument fit the two mounting brackets into the recess provided (see diagram below). Whilst holding the bracket in place, tighten the securing screws being careful not to over-tighten, as this may damage the instrument. Hint: use the elastic band provided to hold the mounting bracket in place whilst tightening securing screws.

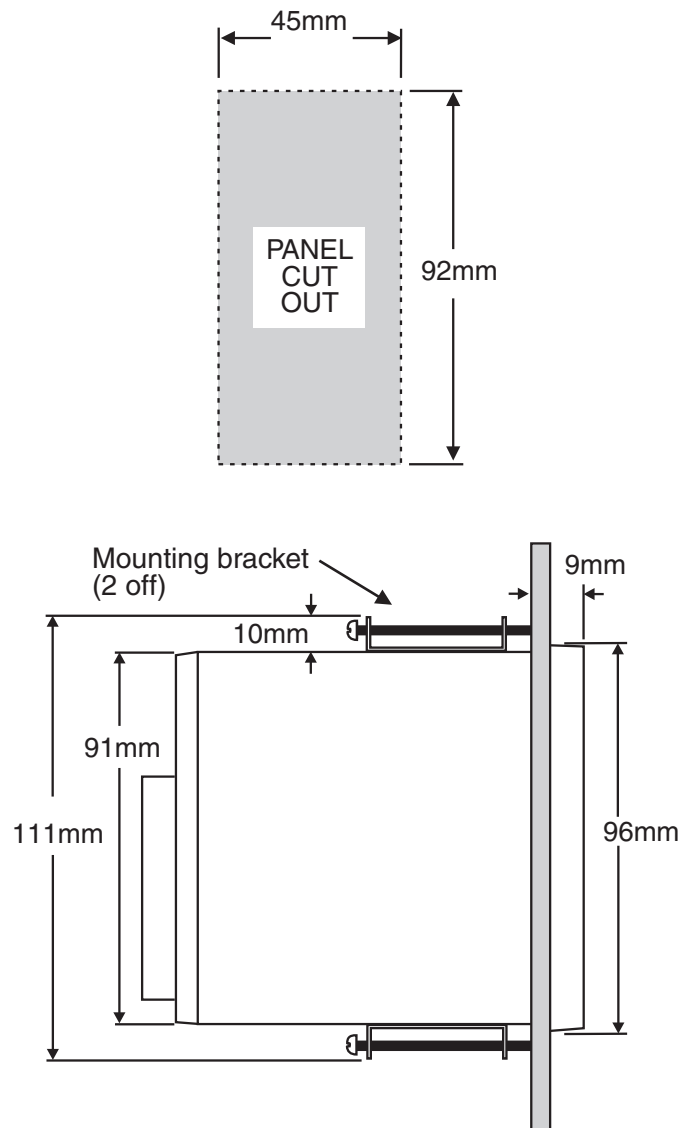

# 3 Electrical installation

## 3.1 Electrical installation

The PM4 Panel Meter is designed for continuous operation and no power switch is fitted to the unit. It is recommended that an external switch and fuse be provided to allow the unit to be removed for servicing. Power supply type is factory configured, check the power supply type fitted before connecting power to the PM4.

The plug in, screw type, terminal blocks allow for wires of up to 2.5mm<sup>2</sup> to be fitted for power supply connections and optional relays and 1.5mm<sup>2</sup> for signal inputs. Connect the wires to the appropriate terminals as indicated below. Refer to connection details provided in this chapter to confirm proper selection of voltage, polarity and input type before applying power to the instrument.

When 4-20mA input is selected the input is protected by a 30mA rated polyfuse, this fuse is self healing but can be permanently damaged by high voltage inputs.

The use of screened cable is recommended for signal inputs.

### Rear connections and typical connection label

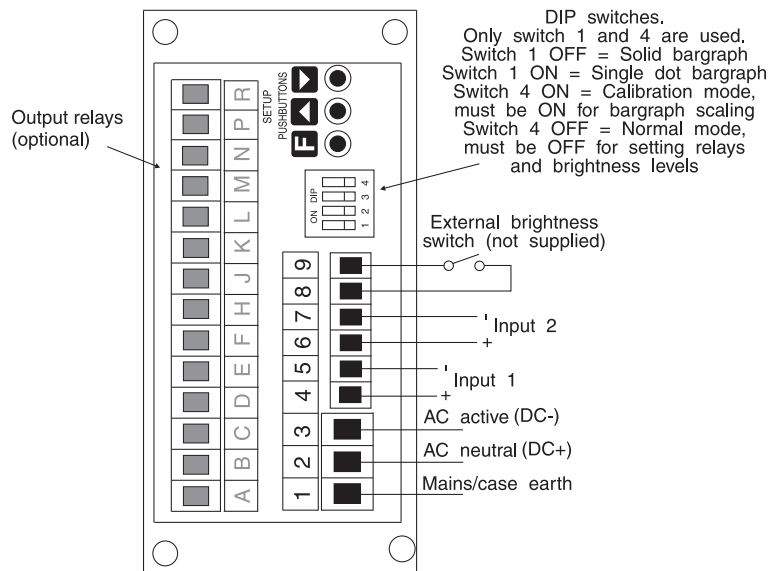

 <b>N1440</b>	
1	MAINS EARTH
2	240 VAC NEUTRAL
3	240 VAC ACTIVE
4	INPUT 1 +VE
5	INPUT 1 -VE
6	INPUT 2 +VE
7	INPUT 2 -VE
8	NOT USED
9	GROUND GND
PM4-IV2-240-BG2	
SERIAL No : XXXXX-XXX	

### 3.2 Electrical connection examples

2 wire 4-20mA externally powered sensor connected to channel 1

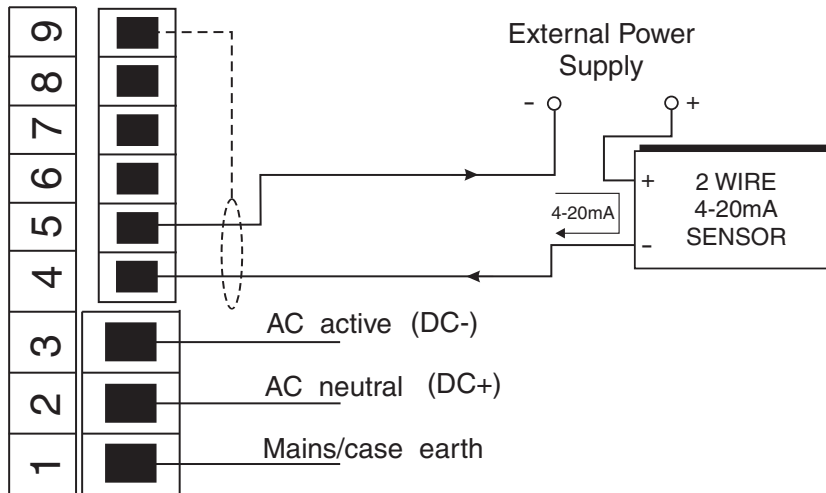

3 wire 4-20mA externally powered sensor connected to channel 1

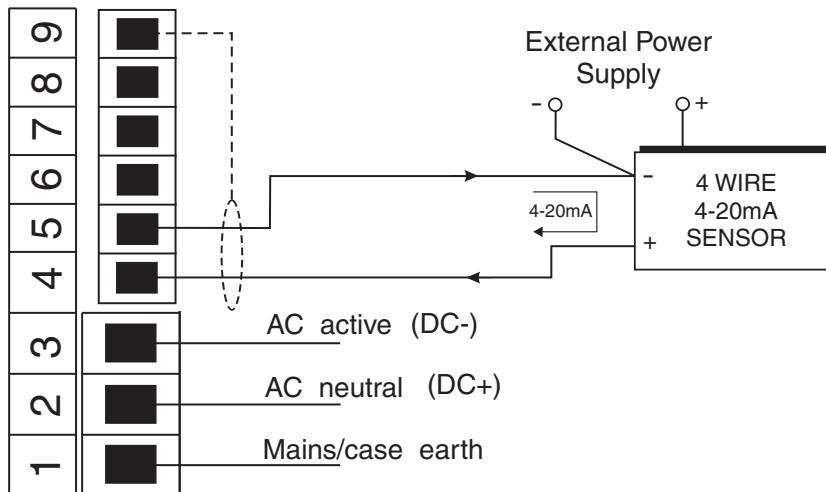

4 wire 4-20mA externally powered sensor connected to channel 1

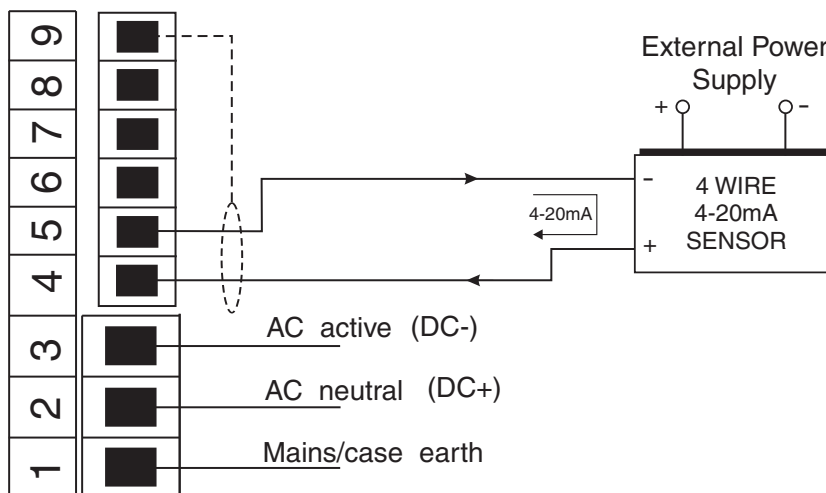

DC voltage input connected to channel 1

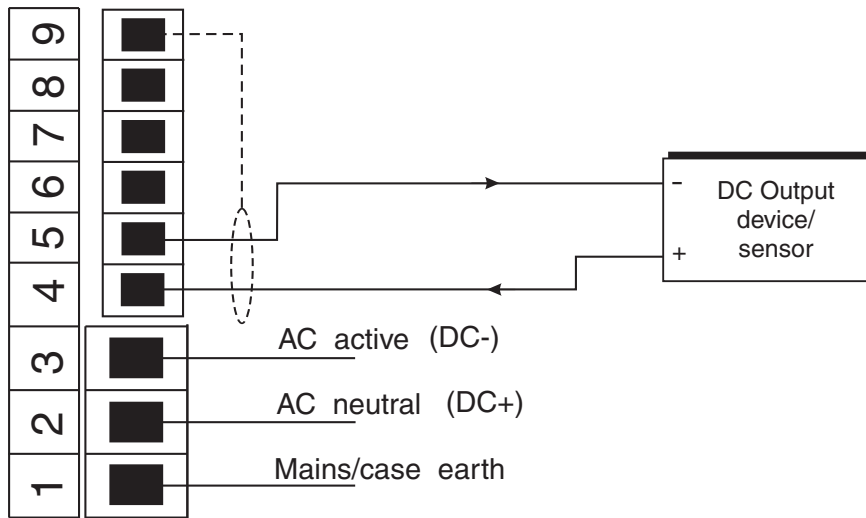



Optional 6 relay board connections

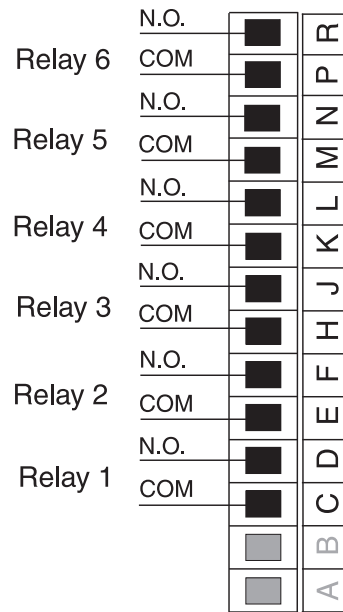

Optional 3 relay board connections

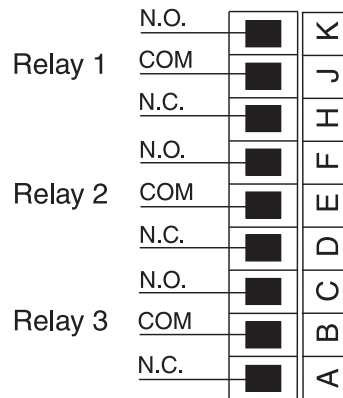

Optional 1 relay board connections

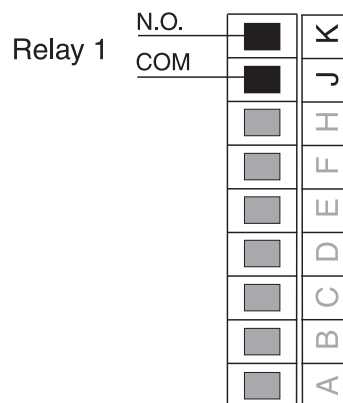

### 3.3 Input Output Configuration

If you need to alter the input or output configuration link settings proceed as follows:

1. Remove the plug in terminals from the rear of the instrument

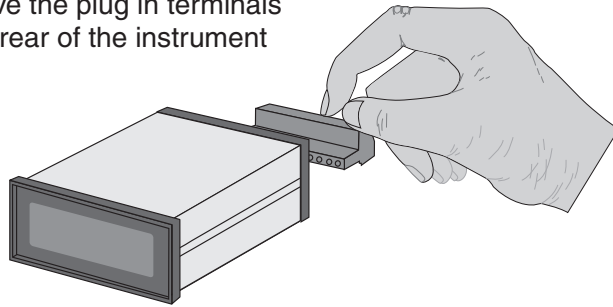

2. Remove the 4 x self tapping screws from the back cover then remove the back cover by pulling it away from the instrument

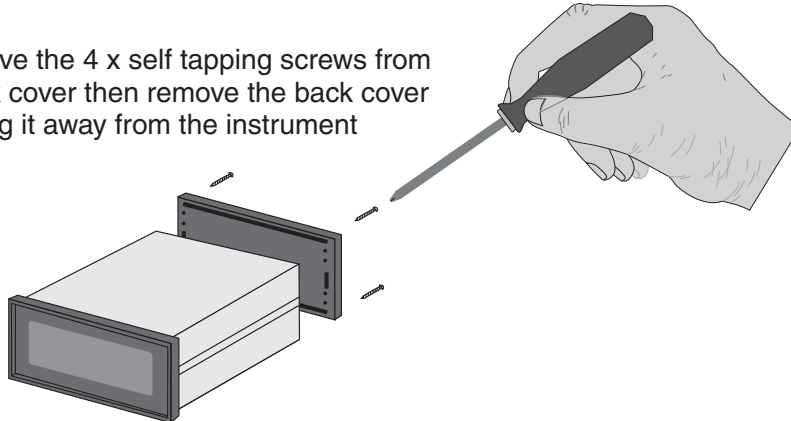

3. Remove the earth screw which passes through the underside of the case then slide out the board or boards

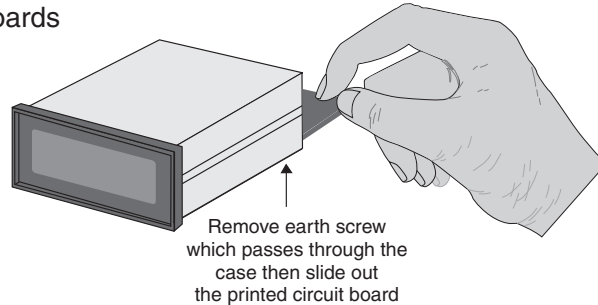

4. Configure the PCB links as required, see appropriate chapter
5. Slide PCB back into case
6. Replace the earth screw which passes through the case
7. Refit the back cover and fix with the self tapping screws
8. Plug the terminal strips back into the rear of the instrument

### 3.4 Input range link selection

Dismantle the instrument as described in section 3.3. Insert the links into the appropriate location on the pin header to suit the range required.

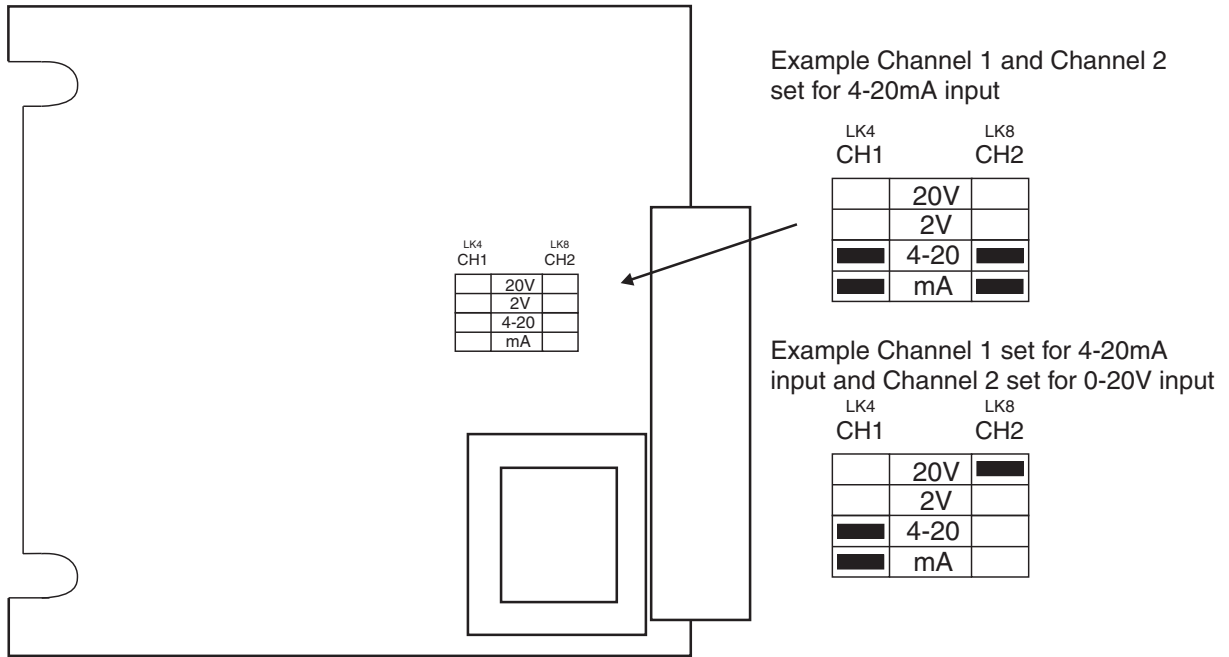

## 4 Bargraph scaling

The rear pushbuttons are used to scale the bargraph. Refer to section 1.2 for details of how to access the setup functions for relay and brightness adjustment. The procedure in section 1.2 must be followed before proceeding to the steps below.

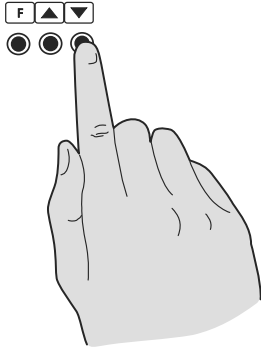

If you wish to scale channel 1 follow the procedure from step 1. If you wish to bypass channel 1 scaling and move to channel 2 scaling press **F** then go to step 4.

1. Apply the 0% input (the signal level required for the low bar indication) to channel 1 then press the **▼** button. Only the bottom segment for channel 1 should now be lit.

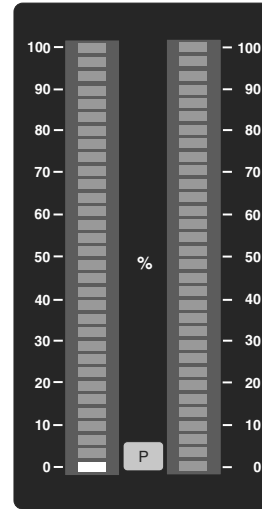

2. Apply the 100% input (the signal level required for all segments to be lit) to channel 1 then press the **▲** button. All segments for channel 1 should now be lit (or the top segment lit if in single segment mode).

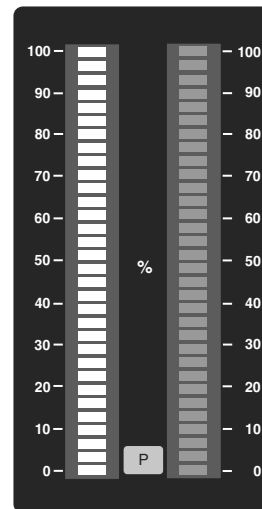

3. Press the **F** button to move to channel 2. All channel 1 segments should now be off.

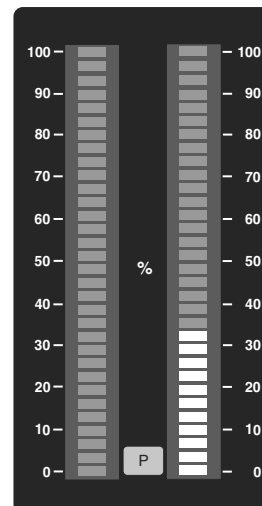

If you wish to scale channel 2 follow the procedure from step 4. If you wish to bypass channel 2 scaling and exit press **F**

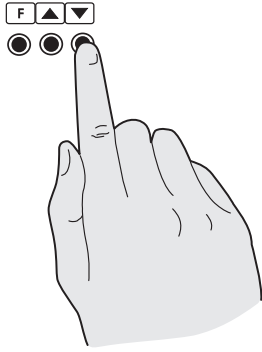

4. At this stage channel 1 bargraph should be blank. Apply the 0% input (the signal level required for the low bar indication) to channel 2 then press the **▼** button. Only the bottom segment for channel 2 should now be lit.

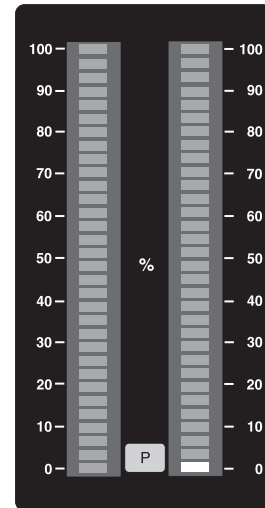

5. Apply the 100% input (the signal level required for all segments to be lit) to channel 2 then press the **▲** button. All segments for channel 2 should now be lit (or the top segment lit if in single segment mode).

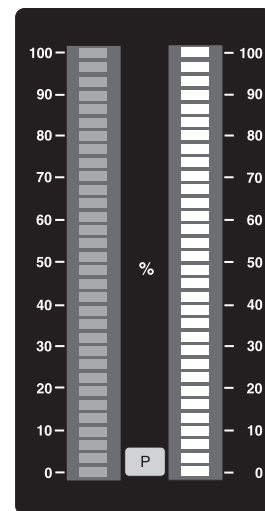

6. Press the **F** button to accept the calibration scaling both bargraphs should now respond to the live inputs using the new scaling.

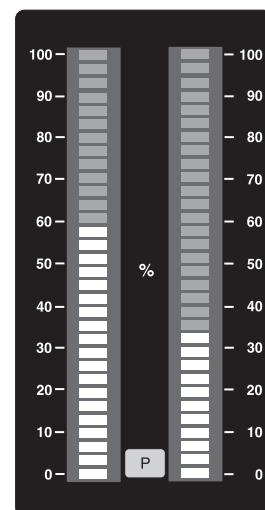

## 5 Warning display

If during scaling both bargraphs flash on and off for 2 to 3 seconds this indicates a span error during scaling i.e. the input for the low bargraph level is the same or too close to the input for the high bargraph level. Check the inputs at low and high levels and rescale the display. There should

be at least 20% off full scale (full scale being the range set by the input links) difference between the input at low and high levels.

## 6 Alarm relay and brightness level settings

The rear pushbuttons are used to set the alarm relays and display brightness levels. The rear DIP switch 4 must be in the OFF position to allow the alarm relays and brightness levels to be set.

### 6.1 Alarm relays

A high alarm or a low alarm setting can be stored for each relay. The number of times the bargraph flashes during setup indicates the relay being set. The bargraph illuminated indicates which input will activate the relay e.g. 3 fast flashes followed by a blank on Channel 2 bargraph indicates relay 3 will operate from Channel 2 if this position is stored. When the required setting has been achieved press the **F** button to store in memory.

If a low alarm is set the relay will close when the display reaches or falls below the level set and will open when the display rises above the level set. If a high alarm is set the relay will close when the display reaches or is above the the level set and will open when the display falls below the level set. Note: the 3 relay option is fitted with changeover relays which allows a choice of normally open and normally closed connections. The single relay and 6 relay options are normally open operation. All relays are voltage free. A hysteresis or "deadband" of one half of a display segment exists to avoid relay chatter around the setpoint. e.g. if a relay has a low alarm of 50% then the relay will activate at 50% or below but will not reset until the input is half a segment above 50%.

Refer to section 1.2 for details of how to access the setup functions for relay and brightness adjustment. The procedure in section 1.2 must be followed before proceeding to the steps below.

When the relay setpoint setup mode has been accessed segments in one or both bargraphs should flash.

Count the number of flashes to identify the relay to be set. If this is not the relay required continue pressing the **F** button until the required relay is reached.

If the 4 middle segments of each channel are flashing as shown in the drawing right this indicates that the relay is turned off for both channels. Any relays not being used should be set to this off position setting.

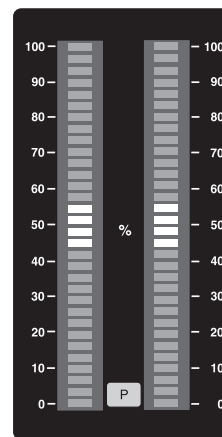

Use the **▲** button to set the level and channel for the relay selected.

The bargraph will cycle from Channel 1 relay low to Channel 1 relay high then to Channel 2 relay low then Channel 2 relay high then to the OFF position. See "Examples" which follow.

When the selection has been made press the **F** button to accept this setting and store it in memory.

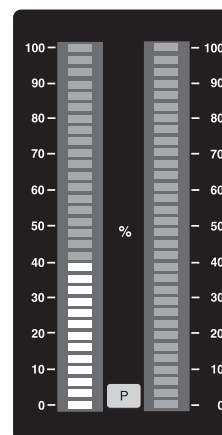

## Examples

Channel 1 low alarm set for approx. 40%

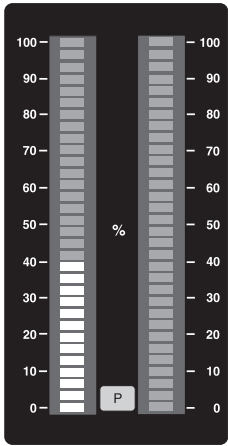

Channel 1 high alarm set for approx. 80%

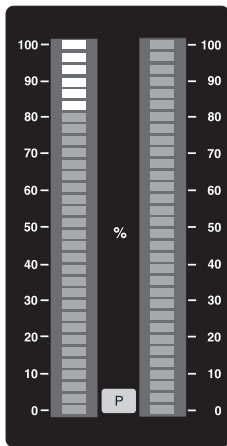

Channel 2 low alarm set for approx. 30%

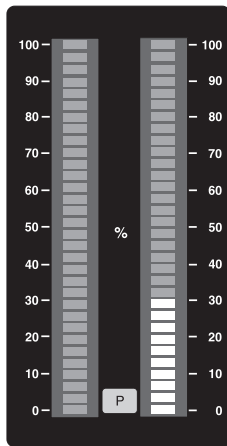

Channel 2 high alarm set for approx. 50%

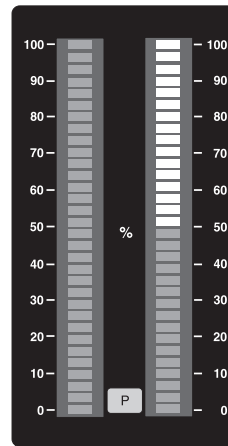

Channel 1 and 2 set to OFF

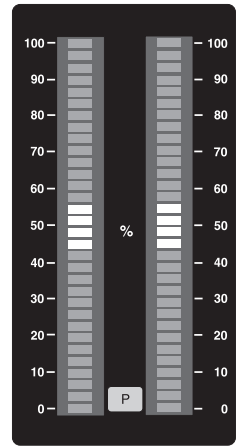

## 6.2 Brightness level settings

The display brightness can be set using the rear pushbuttons. If required 2 levels can be set and switched via an external switch.

### Setting the brightness level

Refer to section 1.2 for details of how to access the setup functions for relay and brightness adjustment.

If relays are fitted then the brightness setting follows the relay settings.

When the brightness setting is accessed both Channel bargraphs will be illuminated. Use the ▲ or ▼ button to set the required brightness level (the bargraph will move up as the brightness increases and down as the brightness decreases).

When the required brightness level is reached press **F** to store this level in memory.

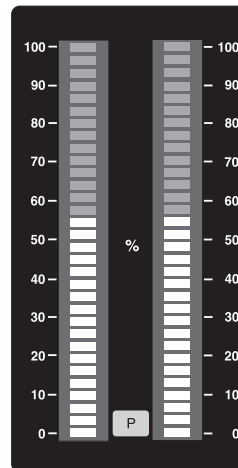

If brightness level switching is required e.g. for day/night viewing levels then fit a switch across terminals 8 and 9 at the rear of the display. Set the brightness level as previously described when the switch is open then close the switch and repeat the process. i.e. the brightness is set once with the switch open and again with the switch closed. In normal operation when this switch is now operated the display will switch between the two levels chosen.



## 7 Specifications

### 7.1 Technical specifications

Input type:	Link selectable 4 to 20mA or 0-2VDC or 0-20VDC (Note: not $\pm 2$ VDC or $\pm 20$ VDC)
Impedance:	Typically $65\Omega$ for 4-20 mA input ( $10\Omega$ plus polyfuse resistance) $1M\Omega$ on DC voltage input
Sample Rate:	4 samples per second for each input
Ambient temp:	-10 to $60^{\circ}$ C
Humidity:	5 to 95% non condensing
Display:	Dual 32 segment bargraphs with red LED segments
Power Supply:	AC 240V, 110V or 24V 50/60Hz or DC isolated wide range 12 to 48V. Special supply types 32VAC, 48VAC 50/60Hz or DC isolated 50 to 110V also available. Note: supply type is factory configured.
Isolation:	Rated at 1kV for 30 seconds, input to input and input to power supply
Power Consumption:	AC supply 4 VA max, DC supply typically 180mA at 12VDC and 90mA at 24VDC Add 10mA at 24V or 20mA at 12V per option relay fitted

### 7.2 Options

Single relay:	Form A rated 5A at 240VAC into resistive load
Three relays:	Form C rated 5A at 240VAC into resistive load
Six relays:	Form A rated 5A at 240VAC into resistive load

### 7.3 Physical Characteristics

Bezel Size:	DIN 48mm x 96mm x 10mm
Case Size:	44mm x 91mm x 120mm behind face of panel
Panel Cut Out:	45mm x 92mm +1mm/-0mm
Connections:	Plug in screw terminals (max. $2.5\text{mm}^2$ for power and $1.5\text{mm}^2$ wire for signal)
Weight:	400 gms

## 8 Guarantee and service

The product supplied with this manual is guaranteed against faulty workmanship for a period of two years from the date of dispatch.

Our obligation assumed under this guarantee is limited to the replacement of parts which, by our examination, are proved to be defective and have not been misused, carelessly handled, defaced or damaged due to incorrect installation. This guarantee is VOID where the unit has been opened, tampered with or if repairs have been made or attempted by anyone except an authorised representative of the manufacturing company.

Products for attention under guarantee (unless otherwise agreed) must be returned to the manufacturer freight paid and, if accepted for free repair, will be returned to the customers address in Australia free of charge.

When returning the product for service or repair a full description of the fault and the mode of operation used when the product failed must be given. In any event the manufacturer has no other obligation or liability beyond replacement or repair of this product.

Modifications may be made to any existing or future models of the unit as it may deem necessary without incurring any obligation to incorporate such modifications in units previously sold or to which this guarantee may relate.

This document is the property of the instrument manufacturer and may not be reproduced in whole or part without the written consent of the manufacturer.

This product is designed and manufactured in Australia.